

CREATING SMILES FOR LIFE



SWIFT

Swift Group Owner's Handbook

Touring Caravans



Rear Wall-mounted Bike Rack

> Thule Elite G2

The perfect all-round bike rack



Extra strong aluminium guarantees stability and reliability.

Bike holders -

Adjustable soft-touch bike holders can easily be repositioned to align with the bike frame.

Lockable platform - The platform lock creates excellent dynamic force control and perfectly secures the bikes during transport. The platform is locked manually and can easily be clicked in the upwards position when not in use.

Wheel holders -

Finding the perfect position for your bike is easy thanks to adjustable wheel holders. They enable you to transport all kinds of bikes with various sizes.

Sliding rails - The rails are adjustable from left to right. They easily slide to make sure you find the best position for your bikes without effort.



- 2 versions: Standard and Short
- 2 bikes, extendable to 3 or 4
- Weight: 10.1kg
- Max. loading weight: 60kg
- Max. bike weight: 30kg
- Max. bike weight 4th rail: 15kg
- Suitable for e-bikes

THETFORD

WORLD'S NO. 1 IN TOILET ADDITIVES!

NEW!

FLUSH-WATER TANK

PLASTIC SURFACES

TOILET BOWL

BLADE SEAL

WASTE-HOLDING TANK

SEAL LUBRICANT

NEW!

PERIODICAL USE WASTE-HOLDING TANK

TOILET BOWL CLEANER

AQUA SOFT THE ORIGINAL

TOILET RINSE

AQUA REM BLUE

AQUA REM BLUE SACHETS

AQUA REM GREEN

AQUA REM GREEN SACHETS

CRISTALIN FRESH

DAILY USE WASTE-HOLDING TANK

www.thetford.com

The only Swift Partner for Paint and Upholstery Protection



Diamondbrite
LEISURE



Paint Protection



Upholstery and Carpet Protection

The only one with the Lifetime Guarantee

From the Makers of Diamondbrite Diamondbrite Leisure

*The ultimate Paint and Upholstery Protection
for your Swift Caravan*

Diamondbrite Leisure is a two-step protection system for your Swift Caravan with a Lifetime Guarantee*

1. EXTERIOR

- Nano-Ceramic Technology
- Fade Resistant
- Never Polish Again!

2. INTERIOR

- Easy to Clean
- Stain Resistant
- Lifetime Guarantee

HOW DOES IT WORK?

1 If your paintwork was magnified it would reveal small pores in the surface.

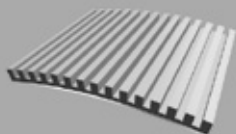

2 Road traffic dirt gathers in the pores and attacks paintwork.

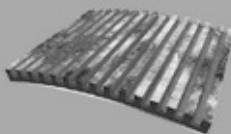

3 Your first Paint Protection application cleanses and fills pores in the vehicles paintwork leaving a smooth finish that cannot be penetrated.

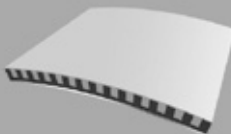

4 Your second application bonds with the first to create a hard protective skin. It leaves a high lustre finish that rain and dirt cannot penetrate.



You will also receive a complimentary After Care pack including the fabulous Waterless Wash, plus a range of other professional cleaning products.

Jewelutra Ltd. Diamondbrite House, Ewell Lane,
West Farleigh, MAIDSTONE. ME15 ONG.

Tel **01622 815679**

Email diamondbrite@jewelutra.com

www.jewelutra.com



MADE IN UK



Diamondbrite
LEISURE

*Lifetime Guarantee applies for the length of time that the purchaser owns the vehicle and is non-transferable.

Refreshed. Relaxed. Recovered.



Stay cool with our
Truma Aventa air
conditioning range for
more comfort

www.trumauk.com/aventa



heating | cooling | controlling



More comfort on the move

A SUCCESS ON
DRAGONS'
DEN

luxury
Comfort
ON THE MOVE



Duvalay are true pioneers – inventing the world's lightest bespoke caravan mattress, as well as innovative sleeping bags and portable toppers which have sold to more than one million customers globally.

To experience affordable bedtime luxury in every place you call 'home', choose Duvalay.

duvalayTM
BEDTIME LUXURY

Order online or by phone
duvalay.co.uk
01274 877 200



NEW!

SATELLITE REVOLUTION!

THE NEW OYSTER® V PACKED WITH
SPECIAL FEATURES.



With inbuilt GPS, 3D Compass and Level Sensor, the Oyster® V always knows exactly where the satellites are. On activation, the new Oyster® V points straight to your selected satellite with no more tiresome searching.

With the very latest technology, the Oyster® V can also be operated on any smartphone or tablet via the ten Haaft App. Software updates are sent automatically to the App and can be easily uploaded to the Oyster® V so your satellite system is always right up to date.

For further information please visit www.ten-haaft.com

Made in Germany



The Active leisure range... long life batteries for life long memories



SWIFT
VALUE ADDED PARTNER



Whether you camp with full electric hook-up or use no mains supply, YBX Active batteries give you the freedom to go anywhere.

Recommended by Swift, Yuasa YBX Active Leisure & Marine batteries are specially designed to provide dependable, stress-free power & long life.

Power your getaway at
www.yuasa.com

YUASA  **BATTERY**



SWIFT

CONNECT DIRECT

WHAT IS CONNECT DIRECT?

Connect Direct is an online system which personalises each customers experience of owning their caravan. The system is now available across the entire range.

HOW DOES IT WORK?

Once you have logged on and created your profile, you will be able to access a whole host of information, specific to your caravan. In addition you will be able to have a direct line into the retail team, with the launch of a live chat facility.

Should a problem occur, you will be able to report a fault to us directly, enabling us to react

quickly and work together with your dealer to take the problem away from you the owner and resolve the issue as quickly as possible.

Product upgrades and notifications will be sent via Connect Direct keeping you up to date over the coming years. This online system provides a direct route for you into the Swift Group, and enables us to provide you with proactive Customer Service support, enhancing your experience.

Connect Direct is in addition to the traditional methods of contacting us.

The key benefits of Connect Direct are:

- Access to information 24/7
- Ability to report faults directly to us
- Product upgrades and notifications
- Live chat direct into our experienced retail team
- Upload service history records
- Service history reminders



CUSTOMER SERVICE



TECHNICAL



REPAIRS



CUSTOMER CHAT



Dear owner

Thank you for deciding to buy one of our new caravans.

We are sure you will enjoy many happy hours in it and we hope the information and hints in this handbook will heighten your enjoyment. The handbook has been designed to give you a general guide to the care, use and maintenance of your caravan. Whether you are a new or an experienced caravanner the hints will help to protect your investment.

The information contained will answer most of your queries, but if there are any aspects which are not covered please consult your appointed dealer. We would suggest you make a note of your dealer's name and contact information below.

Throughout the season, specifications and equipment details contained within this handbook may change. Please refer to our online handbooks (www.swiftgroup.co.uk) for the most up-to-date version of your handbook.

Customers should note that there are two handbooks, the User Handbook which contains general information for the use and care of your product and the Technical Handbook, which contains technical information, weights and dimensions of your product.

Dealer Name:

.....

First Service Due:

.....

Telephone Number:

.....

Dealer Contact Sales:

.....

E-mail:

.....

Dealer Contact Parts:

.....

Serial Number

.....

Dealer Contact Service

.....

1.1 Swift Talk

Swift Talk is the central forum for the Swift community online. A place for all those united in their love of caravanning, motorhomes, holiday homes and touring in general, to share their experiences, meet new friends and find out a world of information on how to enjoy their touring lifestyle.

The site is packed full of features that actively encourage members, not only to liaise with the Swift Group via the forums, but also interact with each other through publishing their own content, uploading and sharing photos and video, and even posting their own blogs for the community to follow.

Swift Talk is the first place to learn about new product launches, events and Swift Group news, it's also the first place customers can go to as a quick reference to frequently asked questions or to actively take part in the forums; providing valuable feedback on Swift Group products and customer service.

The online community can even be used to create your own groups, perfect for Owners' Clubs, dealers and exhibitors to attract new members, publicise and build awareness for upcoming events, rallies and shows.

Anyone who owns, uses, or is thinking of buying a Swift Group caravan, motorhome or holiday home, or would just like to be part of the growing Swift community is actively encouraged to sign up, create their own content, and start talking!

Just visit www.swift-talk.co.uk and become part of a unique online experience.



SWIFT

TALK

1.2 ECWVTA

European Community Whole Vehicle Type Approval is the process used to ensure that motor vehicles (which includes caravans) intended to be placed on the market for consumers meet relevant environmental, safety and security standards.

All Swift Caravans are EC Whole Vehicle Type Approved and therefore meet the rigorous standards for both product design and manufacturing. This approval enables you to register your caravan in any European Union country on production of the Certificate of Conformity. The Certificate of Conformity will have been supplied with the van documentation by the selling dealer.

Duplicate copies can be requested via your Swift dealer.

1.3 NCC approval



All Swift Group models have been certified by the National Caravan Council for compliance with stringent European Standards, British Legislation and industry set Codes of Practice specifically relating to health and safety issues.

The approval process covers the testing and inspection of critical areas of the product from fire safety, weights and dimensions, to gas, electrics and ventilation. Every caravan carries the "NCC Approved Caravan" badge.

The NCC also conduct unannounced inspections at the Swift factory to ensure continued compliance. NCC Approval gives you peace of mind that your caravan is legal and safe.

1.4 CRiS



CRiS is the Central Registration & Identification Scheme that issues touring caravan registration documents, equivalent to that of the V5 registration document issues by the DVLA for cars. CRiS was established in 1992 by The National Caravan Council and provides a method of registering the 'keeper' details of every tourer manufactured by NCC member companies to help prevent and detect caravan related crime.

Why register with CRiS?

• Safety • Security • Warranty

Did you know..?

You should not take a tourer abroad without a registration document. If you go abroad your CRiS registration certificate provides the necessary proof, required by the police and other authorities, that you are its registered keeper.

If you need to make a claim on your insurance, CRiS can help speed up claims by providing details of your tourer and its purchase date to relevant parties.

CRiS can help your tourer's manufacturer contact you in the event that there is any kind of product recall or fault that could affect the safety of your caravan.

For details of CRiS registration see section 6.1

1.5 Thermal insulation and heating

Your caravan has been designed and manufactured to a grade 3 thermal insulation and heating level for specific climatic conditions and tested according to the procedure in EN1645-1.

The classifications are as follows:

Grade 1

A caravan with an average thermal transmittance (u) that does not exceed $1.7w/(m^2k).63$

Grade 2

A caravan with an average thermal transmittance (u) that does not exceed $1.7w/(m^2k)$ and which can achieve an average temperature difference of at least $20^{\circ}C$ between inside and outside temperatures when the outside temperature is $0^{\circ}C$.

Grade 3

A caravan with an average thermal transmittance (u) that does not exceed $1.2w/(m^2k)$ and which can achieve an average temperature difference of at least $35^{\circ}C$ between inside and outside temperatures when the outside temperature is $-15^{\circ}C$.

2. Safety	15
3. Warranty	19
4. CountryCode.....	28
5. TowingGuide.....	29
6. Security.....	53
7. Services.....	59
8. Swift Command Power Control System	91
9. Fitted equipment	119
10. Maintenance	161
11. Useful information	173
12. Index	178

Fire	16
Gas	17
Children	17
CO alarm	17
Ventilation	17
High level bunks	18
Loose entrance step	18
Towing	18

FIRE

The information contained in this handbook is provided for your safety and enjoyment whilst using the product. It is recommended that you read this handbook right through before taking to the road and staying in it for the first time. You will find information, tips and important warnings regarding the use of your caravan. Whilst all the content is important there are specific items, prefixed with a warning, caution or note, which are drawn to your attention for your safety and comfort.

⚠ WARNINGS are instructions that if ignored can cause the user(s) physical harm.

⚠ CAUTIONS are instructions that if ignored can result in damage to the caravan

ℹ NOTES are reminders that should be heeded.

⚠ WARNING For your safety:-

- Ensure all the occupants are aware of the escape routes from the caravan.
- Always keep escape routes and exit points clear from obstruction and hazards.
- Provide one dry powder fire extinguisher of an approved type or complying with EN 3-7, of at least 1kg capacity, by the main exterior door and a fire blanket next to the cooker.
- Familiarise yourself with the instructions on your fire extinguisher and the local fire precaution arrangements.
- Always keep young children away from hot surfaces.

ℹ Note: Your attention is drawn to the notice affixed inside the wardrobe advising on fire precaution, ventilation and what to do in case of fire.

2.1 Fire

In case of fire:

1. Get everyone out of the caravan as quickly as possible using whichever exit is the quickest, including windows. Do not stop to collect any personal items.
2. Raise the Alarm. Call the Fire Brigade.
3. Turn off the gas supply valve if it is safe to do so.
4. Turn off the electricity supply at supply point.

Smoke Alarm Operation

Your caravan is fitted with a Fire Angel SB1 smoke alarm. Please read the smoke alarm user instructions supplied with the caravan. The instructions can also be found at:

<http://fireangel.co.uk/products/sb1-t>



If you are unable to view the documents on line, please contact the supplier, your dealer or Swift for an electronic or paper copy.

Fire Extinguisher

It is recommended that a dry powder fire extinguisher be carried inside your caravan at all times.

After using a dry powder extinguisher it is recommended that the caravan be evacuated until the powder has settled, to avoid inhalation.

A fat pan fire should not have a fire extinguisher aimed at it. It should be smothered with a fire blanket.

Escape paths

It is important that you do not block escape paths to emergency exits with obstructions or hazards.

2.2 Gas

(see also Gas in the services section)

⚠ WARNING: If you smell gas or suspect a leak or in the event of a fire and if it is safe to do so, isolate the gas appliances and turn off the gas bottles at the regulator. Evacuate the caravan and ventilate. Seek professional advice as to the cause of the leak.

⚠ WARNING: Unless en-route heating is in use the LPG cylinder valve should be closed when driving. Isolate all other gas appliances when en-route heating is in use

Gas dispersal vents. All gas appliances and gas taps have a gas dispersal vent within the same compartment. It is essential that these are not blocked or made ineffective

Inspect the high pressure flexible hose regularly for deterioration and replace as necessary.

If your caravan has been fitted with a gas BBQ point it must be only used for its intended purpose.

⚠ WARNING: Do not use a gas barbeque within an awning.

2.3 Children

Do not leave children alone in the caravan in any event. Keep potentially dangerous items out of reach, as at home e.g. matches, medicine etc.

Children under the age of 6 must be supervised whilst using the high level bunks.

2.4 CO alarm

Your caravan is fitted with a Fireangel CO-9D Carbon Monoxide Alarm. Please read the instructions for the alarm, which are available at the following location:

<http://fireangel.co.uk/wp-content/uploads/2015/07/CO-9D%20Manual.pdf>



If you are unable to view the documents on line, please contact the supplier, your dealer or Swift for an electronic or paper copy.

2.5 Ventilation

All caravans comply with BS EN 721. The ventilation points on your caravan are fixed points of ventilation which are required by the European Standards. All caravans have ventilation at high level and low level which has been calculated to suit the individual needs of your caravan. High level ventilation is achieved by means of the roof lights and washroom roof ventilators. The low level ventilators are positioned underneath the oven housing.

Under no circumstances must these vents be blocked or obstructed in any manner as this could lead to insufficient fresh air. In this case the confined atmosphere becomes depleted of oxygen which could lead to dangerous levels of carbon dioxide (CO₂) build up leading to risk of asphyxiation.

The risks of carbon monoxide (CO) build up, which is a colourless, odourless and tasteless gas, will also be reduced with ventilation. Carbon monoxide is produced from incomplete combustion and should the CO detector be activated the cause of the incomplete combustion must be investigated prior to reusing the appliance in question.

It is advised that fixed ventilation points are checked and cleaned (if necessary) on a regular basis using a small brush and a domestic vacuum cleaner.

Additional night time ventilation is obtained by releasing the window catches and placing them in the second groove. Note the windows are not sealed from rain in this position. The ventilation levels are calculated to suit each models requirements and therefore no modifications should be made which may result in reduced ventilation levels.

Please note that the fitment of an air-conditioning unit in place of an existing skylight will reduce the high level ventilation within your caravan. Please contact your dealer to enquire if there is sufficient excess high level ventilation in your caravan to allow fitment of an air-conditioning unit.

⚠ WARNING: Do not obstruct ventilation

2.6 High Level Bunks

The fall out protection provided must always be in place when the upper bunks are in use

Children under the age of 6 must be supervised whilst using the high level bunks.

Lift up high level bunks (where fitted) are designed for a maximum weight of 70 kg (11 stone).

2.7 Loose Entrance Step

The entrance step supplied with your caravan complies with EN1645. Always take care when entering or exiting your caravan ensuring that the step is securely positioned before use. Do not use a damaged or broken step.

2.8 Towing

Note: See the towing guidance and preparing for the road sections for more details on the following items

Wheel Bolts

WARNING: The torque settings should be rechecked regularly. Wheel bolts should NEVER be lubricated. When a wheel has been removed and replaced the torque of the wheel nuts should be re-checked after approximately 30 miles.

Caravan wheel bolts supplied with your caravan should be tightened to a torque of 88Nm (65lb/ft) on steel wheels or 130Nm (96lb/ft) on alloy wheels and should be checked with the use of a torque wrench regularly. Only use a spare wheel and tyre of the type and size provided with your caravan.

Hitching the caravan

- Never attempt to lift the tow hitch with your hands when hitching the caravan to the tow vehicle or at any other time. Always raise or lower the tow hitch by winding the handle on the jockey wheel.
- Always ensure that the green button located on the leading edge of the coupling head is raised before towing.
- Always connect the breakaway cable

- Always connect the 13 pin road light connector and check the operation of the caravan road lights

Driving Licences

Please check that your driving licence covers the tow vehicle/caravan combination. A category B+E driving licence is required for a tow vehicle/caravan combination exceeding 3,500kg.

Tyre Pressures

Tyre pressures should always be checked and corrected prior to each journey. It is vital that tyre pressures are maintained at the levels shown on the plate by the entrance door and in the technical handbook to ensure maximum tyre life, safety and handling characteristics.

Loading

Load your caravan carefully, check the nose weight and place heavy items directly and securely on the floor close to the caravan axle. Travel light for greater fuel efficiency.

Never exceed the Maximum Technically Permissible Laden Mass (MTPLM), axle limits, hitch head capacity and tow ball capacity of the tow vehicle. These limits can be found in the caravan and towing vehicle technical handbooks and on the vehicle statutory weight plates.

WARNING: under no circumstances should the mass limits of the caravan and tow car be exceeded

Warranty 20

Lifetime Water Ingress Warranty 20

Warranty information 22

Change of ownership 23

Service inspection 24

Supplier contacts 27

WARRANTY

All the illustrations and descriptive matter in the handbook are intended to give a general idea of the caravan. Changing market and supply situations and our policy of continuous product development may prevent us from maintaining the exact specifications detailed in the handbook. We therefore reserve the right to alter specifications as materials and conditions demand.

Dealers are not agents of Swift Group Limited ("Swift") and have absolutely no authority to bind the manufacturer by any express or implied undertaking or representation.

Note: To register your warranty, please use the Connect Direct Registration process, by doing so you are agreeing that you have had the details of the warranty and the annual service arrangements fully explained. This in no way affects your statutory rights under the Consumer Rights Act.

Your caravan has three warranties unless you have purchased an Elegance or Elegance Grande based product in which case your caravan has four warranties, as further described below:

3.1 Warranty

SuperSure Warranty

For all parts or fittings of your caravan other than the body shell, Swift will repair (or at its option, replace) any defective parts or fittings for 3 years from the date of purchase (or hire purchase) subject to conditions, terms and exclusions below.

Body Shell Warranty

For the body shell, Swift will repair (or at its option, replace) any defects with the body shell for 6 years from the date of purchase (or hire purchase), subject to the conditions, terms and exclusions below.

Extended Body Shell Warranty

For the first owner, Swift will repair (or at its option, replace) any defects with the body shell for 10 years from the date of purchase (or hire purchase), subject to the conditions, terms and exclusions below.

Lifetime Water Ingress Warranty

(Applicable to Elegance and Elegance Grande based products only).

Elegance or Elegance Grande based products, have the benefit of a fourth warranty; the Lifetime Water Ingress Warranty. This warranty is available to the first registered owner of an Elegance and Elegance Grande based product for up to 25 years of ownership. This warranty shall be effective from the date of purchase (or hire purchase) and is subject to the "Conditions" which are set out in the paragraph below.

Conditions

1. You must ensure that your caravan has had an Annual Service (see clause 2 below) within 90 days before or 60 days after each anniversary of the original date of purchase. In order to preserve:
 - Your SuperSure Warranty, the third Annual Service must be carried out before the expiry of the 36 month period from the original date of purchase;
 - Your Body Shell Warranty, the sixth Annual Service must be carried out before the expiry of the 72 month period from the original date of purchase;
 - Your Extended Body Shell Warranty, the tenth Annual Service must be carried out before the expiry of the 120 month period from the original date of purchase;
 - If applicable, your Lifetime Water Ingress Warranty, the twenty fifth Annual Service must be carried out before the expiry of the 300 month period from the original date of purchase.

If your caravan has not had its Annual Service, in accordance with the terms of this handbook, then Swift will not be obliged to perform any work under the applicable warranties. Original VAT invoices must be retained as proof that Annual Services have been carried out.

2. The Annual Service must be carried out in accordance with the requirements in this handbook. You will be responsible for any charges made for an Annual Service. If the Annual Service is performed by an authorised Swift Group Service Centre

then Swift warrants that the Annual Service has been performed correctly. If the Annual Service is performed by an unauthorised repairer or service centre then if the Annual Service has not been performed in accordance with the requirements in this handbook and/or work has been performed on your caravan that is defective or faulty, then Swift will not be obliged to perform any work under this Warranty (insofar as it relates to defective or faulty work or defective Annual Service).

3. All new caravans must be registered with Swift within 6 weeks of purchase as new.
4. The benefit of the SuperSure Warranty and Body Shell Warranty may be transferred to a new owner if the caravan is re-sold, provided that the caravan has been serviced in accordance with the requirements of this handbook, and details of the change of ownership have been supplied to Swift using the change of ownership form set out in this handbook as soon as reasonably practicable after the change.
5. The benefit of the Extended Body Shell Warranty is non-transferable to new owners and applies only to the original registered owner.
6. The benefit of the Lifetime Water Ingress Warranty on the Elegance and Elegance Grande based products, is non-transferable to new owners and applies only to the original first registered owner.
7. If any repairs are identified as being necessary during an Annual Service or otherwise, Swift will only pay for Warranty work performed by an authorised Swift Group Service Centre. The caravan must be made available to an authorised Swift Group Service Centre within 6 weeks of the date the repair need was identified for the work to be carried out. The cost of transporting, towing or moving the caravan by any means to or from the place of repair is the responsibility of the owner.
8. The SuperSure Warranty, the Body Shell Warranty and/or the Extended Body Shell

Warranty only apply to caravans purchased and used primarily within the UK. The Lifetime Water Ingress Warranty only applies to Swift Elegance and Elegance Grande based products purchased and used primarily within the UK.

Terms

9. The Body Shell Warranty and Extended Body Shell Warranty cover any defect with the panels and seams of the caravan. This includes body leaks, delamination of panels or floor, water ingress through any permanently sealed seam joints.
10. The Lifetime Water Ingress Warranty cover water ingress through permanently sealed seam joints on Swift Elegance and Elegance Grande based products.
11. The SuperSure Warranty will cover in the first 12 months any defect other than those specified in the Exclusions below.
12. In years 2 and 3 of the SuperSure Warranty, the Warranty will only cover any defect with the following components:
 - **Chassis Components:** all chassis members, including corner steadies, overrun device, axle and braking system (excluding brake drums and shoes)
 - **Electrical System:** PSU, battery charger, Smart Command and interior lighting units (excluding bulbs).
 - **Water System:** water heater, fresh water tank, water pump, water gauges, taps and shower head.
 - **Cooker:** the cooker unit including grill, oven, burners, igniter and flame failure device.
 - **Refrigerator:** gas igniter, flame failure device, door seal condenser, gas control valve, 12V and 230v heater elements, gas thermostat, 230v thermostat and 230v temperature control switch.
 - **Cassette Toilet:** the cassette toilet (excluding seals, valves and glands).
 - **Heating System:** thermostat, motor, switches, control unit, gas heater, flame failure device and igniter (excluding ducting and fittings).

WARRANTY

- **Windows:** the functionality of the opening and closing system (stays, handles and catches) and a warranty against the cracking of the acrylic. Excludes fading.
- **Upholstery:** zips, seams and colour fastness.

In years 2 and 3 of the SuperSure Warranty, any defect specified in the Exclusions will not be covered.

Exclusions

13. Swift shall not be liable under this Warranty for any defect related to or arising from the following:
- The failure of a component for reasons of fair wear and tear;
 - Damage resulting from freezing, fire, overheating or accidents (whether caused by the user or a third party);
 - Misuse of any component;
 - Normal deterioration, corrosion, intrusion of foreign or harmful bodies, lack of servicing or negligence of any person other than Swift which causes stoppage of or impairment to the function of any component of the caravan;
 - Replacement of parts which have reached the end of their effective working life because of age and/or usage;
 - Cleaning or adjustment of any assemblies;
 - Cosmetic finishes to kitchen sinks, cooker tops, vanity units, shower trays.
 - Damage caused by any abrasive cleaners
 - Issues related to condensation in normal use;
 - Routine maintenance items which are part of the annual service including brake shoes, one shot nuts, lubricants, AKS pads, rubber gas hose, the cleaning of the heater and fridge flues, the replacement of gas jets, the resealing and/ or replacement of shower room sealant, and the adjustment and lubrication of locks.

14. In addition to the exclusions above, in years 2 and 3 of the SuperSure Warranty Period, Swift Group Limited shall not be liable under this Warranty for any defects related to:

- **Alloy wheels:** after 24 months from date of purchase, this excludes wear and tear, (tyres & valves excluded).
- **Wall and Roof GRP sheeting material:** after 24 months from date of purchase only

Warranty information

Swift shall also not be liable under the SuperSure, Body Shell, Extended Body Shell or the Lifetime Water Ingress Warranties (if applicable) if the Caravan has been neglected, misused, modified or used for hire or reward or if the identification marks (chassis/VIN numbers) have been removed or defaced. The caravan will be deemed to have been neglected if it has not been serviced and maintained as stated in this handbook or any repairs being identified as necessary at an Annual Service or by a Swift Group Service Centre have not been carried out in a reasonable time.

You have legal rights under UK law governing the sale of consumer goods. These warranties do not affect your legal rights.

The name and address of the Warranty provider is:

Swift Group Limited, Dunswell Road, Cottingham, East Yorkshire, HU16 4JX

To make a claim under this warranty, contact the dealer which supplied your caravan. If this is not possible then contact the Swift Group Customer Services Department on 01482 875740, or enquire on the website www.swiftgroup.co.uk

3.2 Change of ownership

You can transfer the remainder of any 3 year 'Supersure warranty' and the 6 year 'body shell' warranty, details of how to do this can be found at the rear of this handbook. The 'Extended Body Shell Warranty' is non transferable.

3.3 Swift Connect Direct

You have access to an online system which is specific to your new caravan. A password will be issued to you, to enable you to interact with us. To access the system, called 'Swift Connect Direct', your initial log in details will be emailed to you once your supplying dealer has registered your ownership with us. Please log in and create your own profile. Should you have issues with accessing Swift Connect Direct, please contact our Customer Services Team.

What to do if you require assistance

Should you have an enquiry or require assistance with a problem, we hope that this guide will be of assistance to you.

Please follow these steps:

1. Check the Owners Handbook, paying particular attention to the fault finding advice at the back of the book.
2. Contact your supplying dealer for assistance.

If you need to contact the Swift Group, please be aware of the following:

1. When contacting Swift Customer Service, please quote your name, postcode and serial number of your caravan. This can be found on the weight plate labels located next to the exterior door and inside the gas locker. It is also etched into the side windows.
2. In most instances, the Customer Service Team will involve your dealer in resolving the issue you are experiencing.
3. Check our website www.swiftgroup.co.uk and enter the Owners section which provides answers to frequently asked questions and how to contact us.

4. If you are contacting the company by email, letter or fax, the Customer Service Team will respond to you within five working days from the date of receiving the correspondence.
5. Please be aware that the Swift Group cannot send parts direct from the factory. In all cases, without exception, your dealer must place the order for you.

SERVICE INSPECTION

Touring caravans - annual service/inspection record

In order to comply with the warranty, you must have your caravan inspected and serviced at least once per year.

We highly recommend that you have your Touring Caravan serviced by a Swift Group Approved Service Centre who have direct access to our online Customer Service system, Connect. This system provides them with the ability to order approved parts and ensure that any product upgrades which may be available for your Touring Caravan can be offered to you and carried out as part of the service. In the unfortunate event that an issue requires attention under warranty then a Swift Group Approved Service Centre are able to submit a warranty claim to the Swift Group for processing, and deal with the issue for you from start to finish. All of our Swift Group Approved Service Centres are provided with up to date technical information and have access to current repair methods giving you peace of mind that any defect has been repaired effectively.

It is important that the Service inspection Record is updated. Your Swift Group Service Centre have the facility to do this on line. Should proof of service be requested at any time you will need to produce a copy of the service invoice, therefore please keep this for your records. Failure to provide proof of service may invalidate the warranty and the transfer of the warranty on the change of ownership.

The inspection should take approximately two to four hours and will cover the areas dealt with in the annual service check list. Any areas requiring service and/or maintenance will be highlighted by your dealer and we recommend that you authorise any necessary work to be carried out.

Note: It is essential, to validate the warranty, that an annual inspection be carried out by an authorised Swift Group Service Centre covering the items listed.

1. Damp and lamination test. This is a visual inspection of bodywork and seals.
2. Coupling head and breakaway cable.
3. Jockey wheel.
4. Chassis and chassis to body security.
5. Corner steadies.
6. Tyres and tyre pressures.
7. Torque wheel nuts.
8. Brake rods and linkages.
9. Hub bearings, brakes and brake shoes.
10. Handbrake operation and performance.
11. Suspension and shock absorbers (if fitted).
12. 13-pin plug and cables.
13. Road lights, wiring and reflectors.
14. Internal lights and 12V DC system.
15. Water heater - gas and 230V AC (if fitted).
16. Hob, grill and oven (if fitted).
17. Refrigerator 230V AC, 12V DC and gas.
18. Gas system.
19. Water pump, taps and water system.
20. Mains 230V AC system.
21. Windows and fittings.
22. Smoke alarm and battery.
23. Roof lights.
24. Furniture hinges/stays etc.
25. Exterior locks and hinges.
26. Grab handle security.
27. All internal vents.
28. Oil seals.
29. Blinds and fly screens (if fitted).
30. Carbon Monoxide detector.

<p>Annual service / inspection record stamps</p> <p>Caravan model:</p> <p>Year:</p> <p>Chassis Number:</p>	<p>1st service</p> <p>Date:</p> <p>Dealer's Stamp</p> <p>We certify that an annual service has been carried out in accordance with the handbook.</p>
<p>2nd service</p> <p>Date:</p> <p>Dealer's Stamp</p> <p>We certify that an annual service has been carried out in accordance with the handbook.</p>	<p>3rd service</p> <p>Date:</p> <p>Dealer's Stamp</p> <p>We certify that an annual service has been carried out in accordance with the handbook.</p>
<p>4th service</p> <p>Date:</p> <p>Dealer's Stamp</p> <p>We certify that an annual service has been carried out in accordance with the handbook.</p>	<p>5th service</p> <p>Date:</p> <p>Dealer's Stamp</p> <p>We certify that an annual service has been carried out in accordance with the handbook.</p>
<p>6th service</p> <p>Date:</p> <p>Dealer's Stamp</p> <p>We certify that an annual service has been carried out in accordance with the handbook.</p>	<p>7th service</p> <p>Date:</p> <p>Dealer's Stamp</p> <p>We certify that an annual service has been carried out in accordance with the handbook.</p>

SERVICE INSPECTION

<p>8th service</p> <p>Date: Dealer's Stamp</p> <p>We certify that an annual service has been carried out in accordance with the handbook.</p>	<p>9th service</p> <p>Date: Dealer's Stamp</p> <p>We certify that an annual service has been carried out in accordance with the handbook.</p>
<p>10th service</p> <p>Date: Dealer's Stamp</p> <p>We certify that an annual service has been carried out in accordance with the handbook.</p>	<p>11th service</p> <p>Date: Dealer's Stamp</p> <p>We certify that an annual service has been carried out in accordance with the handbook.</p>
<p>12th service</p> <p>Date: Dealer's Stamp</p> <p>We certify that an annual service has been carried out in accordance with the handbook.</p>	<p>13th service</p> <p>Date: Dealer's Stamp</p> <p>We certify that an annual service has been carried out in accordance with the handbook.</p>
<p>14th service</p> <p>Date: Dealer's Stamp</p> <p>We certify that an annual service has been carried out in accordance with the handbook.</p>	<p>15th service</p> <p>Date: Dealer's Stamp</p> <p>We certify that an annual service has been carried out in accordance with the handbook.</p>

3.4 Supplier contacts

A number of Swift Group suppliers manage their own Technical and Warranty related queries. Where a customer has a question relating to a product manufactured by a company listed below, we would advise that the first contact should be directly with them.

	<p>Sargent Electrical Services Unit 39, Tokenspire Business Park, Beverley, East Yorkshire, HU17 0TB Phone: 01482 678981 Fax: 01482 678987 E-mail: support@sargentltd.co.uk</p>	<p>https://sargentltd.co.uk</p> 
	<p>AL-KO Kober Limited South Warwickshire Business Park Kineton Road, Southam, Warwickshire, CV47 0AL Fax: 01926 818562 Email: mail@al-ko.co.uk</p>	<p>http://www.al-ko.co.uk</p> 
	<p>Truma UK Ltd. Park lane, Dove Valley Park, South Derbyshire, DE65 5BG Phone: 01283 586020 Fax: 01283 586029 technical@trumauk.com</p>	<p>https://www.truma.com/uk/en/home/index.php</p> 
	<p>Thetford Ltd. Unit 6, Brookfields Way, Manvers, Dearne Valley, Rotherham, South Yorkshire, S63 5DL Phone - 0844 997 1960 Fax - 0844 997 1961 Email - info@thetford.eu</p>	<p>https://www.thetford-europe.com</p> 
	<p>Alde International (UK) Ltd Huxley Close, Park Farm South, Wellingborough, Northants, NN8 6AB Phone: 01933 677765 Fax: 01933 674975 Email: info@alde.co.uk</p>	<p>www.alde.co.uk</p> 
	<p>Dometic (UK) Ltd Dometic House, The Brewery, Blandford St Mary, Dorset, DT11 9LS Phone: 0844 626 0133 Email: technical@dometic.co.uk</p>	<p>https://www.dometic.com/en-gb/uk</p> 
	<p>Whale 2 Enterprise Road, Bangor, Co. Down, Northern Ireland BT19 7TA Phone: 0845 217 2933 Email: info@whalepumps.com</p>	<p>http://whalepumps.com</p> 

4.1 Respect - Protect - Enjoy

Respect other people:

- Consider the local community and other people enjoying the outdoors
- Leave gates and property as you find them and follow paths unless wider access is available

Protect the natural environment:

- Leave no trace of your visit and take your litter home
- Keep dogs under effective control

Enjoy the outdoors:

- Plan ahead and be prepared
- Follow advice and local signs

For more details see https://assets.publishing.service.gov.uk/government/uploads/system/uploads/attachment_data/file/701188/countryside-code.pdf



Caravan terms	30
Towing vehicle terms	32
Driving licence	32
Towing vehicles	33
Loading	33
Measurement of nose weight	35
Towing stability	36
AL-KO ATC trailer control system (where fitted)	36
Tow ball / hitch head	37
Hitching up	37
Towing the caravan	45
Arrival on site	46
Tyres and wheels	48
Changing a wheel	50
Miscellaneous equipment	51

CARAVAN TERMS

The NCC have published an extensive towing guide which can be found at:

https://www.thencc.org.uk/downloads/NCC_Towing_Guide_0415.pdf



This guide will be of particular use to new and inexperienced caravan owners.

5.1 Caravan Terms

Empty weight:

The empty weight of the caravan includes all loose items supplied by Swift e.g electric hook up cable, kit bag, entrance step, portable waste tank & central heating fluid (where applicable)

Note: ALKO Wheel Locks should be carried in the towing vehicle

Mass in Running Order: (MRO)

The mass of the caravan equipped to the caravan manufacturer, standard specification. The MRO comprises the empty weight of the caravan and includes an allowance for gas.

Note: The mass of the caravan in running order contains provision for the masses of liquids, gas etc. (see MRO in the Technical Handbook). Part of this provision can also be utilised as additional payload if, for example, you wish to travel with no gas cylinders.

Maximum User Payload:

The maximum allowable weight to be put into the caravan whilst it is being towed. This is made up of the personal effects and the optional equipment payloads. The user payload is the difference between the MTPLM (see below) and the MRO.

Personal Effects (PE)

Those items which a user can choose to carry in a caravan.

Note: The Personal effects payload includes an allowance of 20kg for a leisure battery.

Outfit

The car and caravan combination.

Optional Equipment (OE)

Items made available by the manufacturer over and above the standard specification of the caravan for factory fitted options.

Maximum Technically Permissible Laden Mass (MTPLM) (Lower Limit):

The fully laden mass of the caravan in the manufacturer's standard specification which is stated in the publications, technical handbooks, brochures and weight plate and used for tow vehicle matching.

$MRO + PE + OE = MTPLM$

MTPLM (Upper Limit):

The mass takes into account specific operating conditions including factors such as the strength of materials, loading capacity of tyres, etc.

WARNING: Under no circumstances should the maximum technically permissible laden mass (MTPLM) be exceeded.

Payload Definition

The method of calculating MRO and user payload figures are in line with European Vehicle regulations.

Note: The allowances for essential equipment is now contained within the MRO of the caravan, as per NCC Code of Practice (CoP) 304. This includes the following: LPG 1 x cylinder = 10kg (20kg if Duo Comfortor Duo Control regulator is fitted)

The MRO is calculated with the fresh water tank empty (where fitted).

Note: If you travel with water in the fresh water tank, the payload will be reduced accordingly.

The leisure battery is considered to be included in the personal effects and an allowance of 20kg has been made for this. Items fitted at the point of manufacturer (hookup cable, plastic steps, waste containers, etc.) are included within the vehicle MRO.

Upgrading of maximum technically permissible laden mass:

The lower (or standard) MTPLM is quoted in the Technical Handbook, in brochures and on the caravan weight plate. However, in some cases it may be possible to increase this to a higher (upper) MTPLM. (See Technical Handbook for details).

If extra user payload is required, an upgrade maybe available (model dependant), this must be requested via your dealer and is chargeable.

Note: Tyre pressures may increase when upgrading the MTPLM.

Nose weight:

The nose weight is the static vertical load transferred to the towing vehicle through the coupling head.

Notes:

- i. When measuring the nose weight it is important that the caravan is fully loaded. Do not place extra items indiscriminately into the caravan after this adjustment has been made.
- ii. The caravan is intended to be towed slightly nose heavy. The nose weight can be adjusted by distribution of the load within the caravan. The nose weight should be approximately 5-7% of the actual laden weight (but not greater than the hitch capacity) and at the same time suit the towing vehicle. See section on Measurement of Nose Weight.
- iii. It is not recommended that you tow with just a battery, spare wheel and gas bottles as this may exceed the permitted nose weight. Additional payload must be placed behind the axle to compensate for this.

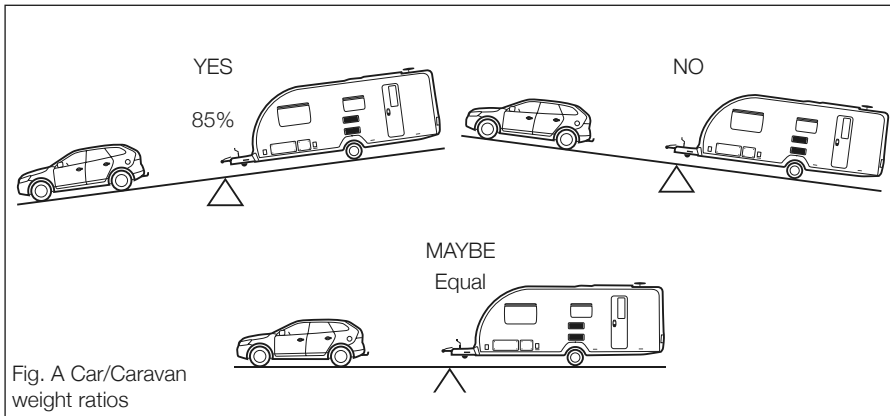

5.2 Towing Vehicle Terms

Kerb weight

This is the weight of the towing vehicle as defined by the vehicle manufacturer. This is normally with a full tank of fuel, with an adequate supply of liquids incidental to the vehicles propulsion, without driver or passengers, without any load except loose tools and equipment with which the vehicle is normally provided and without any towing bracket.

Caravan to Towing Vehicle Weight Ratio:

The towing vehicle to caravan weight ratio can be determined by calculation and is equal to:

Actual laden weight of caravan

_____ x 100%

Kerb weight of towing vehicle

The law requires that caravans & their towing vehicles & the loads they carry must be in such a condition that no danger or nuisance is caused.

(Regulation 100 of the Road and Vehicles [Construction and Use] Regulations 1986).

Note: The towing vehicle manufacturer's limit is, in some cases, less than the kerb weight.

Mass in Running Order:

Caravanners can use a public weigh bridge to establish the mass in running order.

Note: Weigh bridges are generally designed for large goods vehicles and therefore usually weigh in increments of 20 kg. They also have varying weight tolerance levels.

Maximum Permissible Towing Mass:

The weight defined by the vehicle manufacturer as being the maximum that the vehicle is designed to tow.

Train Weight (Combination Weight):

The maximum combined weight of the towing vehicle and trailer combination as specified by the towing vehicle manufacturer.

5.3 Driving Licence

If you passed your car test before 1st January 1997 you are generally entitled to drive a vehicle and trailer combination up to 8,250kg maximum authorised mass (MAM). This is the weight of a vehicle or trailer including the maximum load that can be carried safely when it's being used on the road.

You can also drive a minibus with a trailer over 750kg MAM.

If you passed your driving test after 1st January 1997 and have an ordinary category B (car) licence, you can:

- Drive a vehicle up to 3,500kg MAM towing a trailer of up to 750kg MAM
- Tow a trailer over 750kg MAM as long as the combined MAM of the trailer and towing vehicle is no more than 3,500kg

For anything heavier you need to take a category B+E driving test.

From 19th January 2013, drivers passing a category B (car) test can tow:

- Small trailers weighing no more than 750kg
- A trailer over 750kg as long as the combined weight of the trailer and towing vehicle is no more than 3,500kg MAM

If you want to tow a trailer weighing more than 750kg, when the combined weight of the towing vehicle and trailer is more than 3,500kg, you'll have to pass a further test and get B+E entitlement on your licence.

5.4 Towing Vehicles

Suitable towing vehicles

The caravan is manufactured for towing behind normal road cars and is not suitable for towing behind commercial vehicles. It is strongly recommended that whenever a caravan is to be towed over rough terrain, e.g. a field or track, great care should be taken to ensure that no undue stress is placed upon the caravan via the hitch mounting, i.e. reduce speed. If in doubt, please consult the chassis manufacturer and the towing vehicle manufacturer who will advise. Touring caravans based on standard AL-KO chassis can be towed by four wheel drive off road leisure vehicles providing the unit is used to tow in a like manner to a conventional road-going car and driven in the same considered manner.

Tow bar manufacturers should be consulted before towing a Swift twin axle caravan which are fitted with an uncompensated twin axle.

5.5 Loading

⚠WARNING: Never enter the caravan without first lowering the four corner steadies with the brace provided.

Before loading check:

Loose articles are stowed securely. Do not stow tins, bottles or heavy items in overhead lockers prior to towing.

All lockers and cupboard doors are closed and secured, including the bathroom door.

All bunks are secure.

Ensure shower door is secure

All rooflights are closed and secured.

Tables are stored in their transit positions.

The television aerial is lowered and locked in travel position, where relevant

The fridge is on 12V operation and door lock is set.

All windows and service doors are fully closed and latched. Never tow with windows on night setting. Leave all curtains and blinds open to aid rear visibility.

Gas cylinders are correctly positioned, secured and turned off, unless using en route heating. (See gas in services section)

Battery is secure and mains connecting cable is disconnected and stowed.

⚠WARNING: Turn off gas appliances except en route heating (if fitted).

⚠WARNING: Do not travel with televisions or microwaves in overhead lockers unless the appliance was supplied fitted to your caravan by the manufacturer.

⚠WARNING: Always disconnect the electrical connector between the towing vehicle and the caravan before connecting an LV supply to the caravan.

LOADING

How to position the payload

1. Load heavy items low down near the floor and mainly over or just in front of the axle(s) (Fig. A).
2. Load evenly right to left so that each caravan wheel carries approximately the same weight. (Fig. B)
3. Do not load items at the extreme front or rear since this can lead to instability due to the 'pendulum effect'. (Fig. C)
4. Load the remainder of the payload to give a suitable nose weight at the towing coupling.
5. Check nose weight. (See overleaf)

⚠ CAUTION: Do not overload car boot.

⚠ WARNING: All heavy and/or voluminous items (e.g. TV, radio etc) must be stored securely before travelling.

⚠ WARNING: Please take care to ensure that you have allowed for the masses of all items you intend to carry in the caravan, e.g. optional equipment, and personal effects such as clothing, food, pets, bicycles, sailboards, sports equipment etc.

⚠ WARNING: Under no circumstances should the MTPLM of this caravan be exceeded

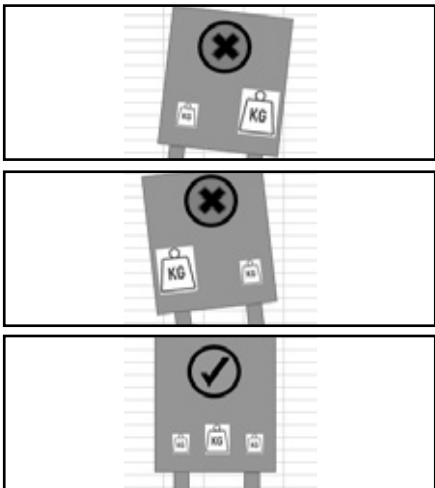

Fig. B

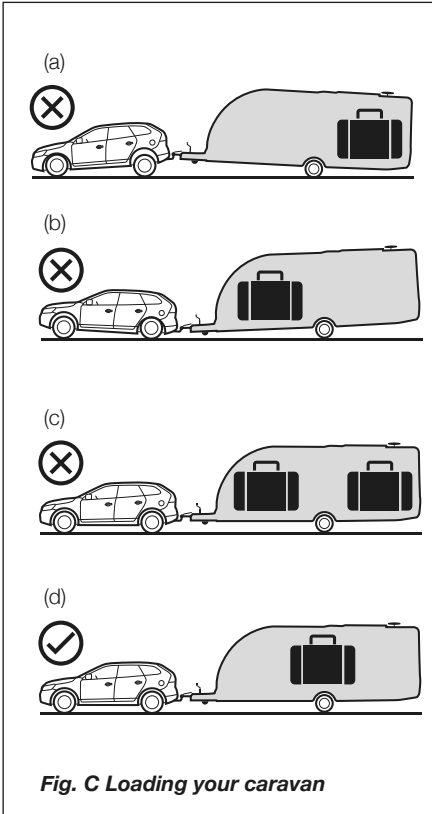

Fig. C Loading your caravan

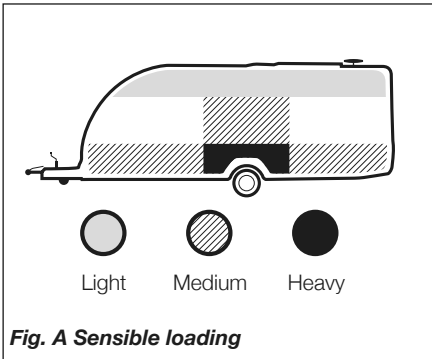

Fig. A Sensible loading

Towing vehicle's rear suspension

It is important that the towing vehicle's rear suspension is not deflected excessively by the nose weight on the tow ball. If it is excessive the steering and stability will be affected.

(Fig. D)

The greater the towing vehicle's tail overhang (the distance between the rear axle and the tow ball), the greater the effect the nose weight will have on the towing vehicle's rear suspension.

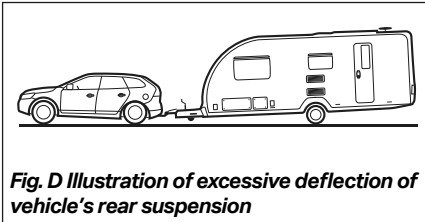

Fig. D Illustration of excessive deflection of vehicle's rear suspension

After trying out the caravan it may be found that a stiffening of the rear suspension is necessary - but note that this may give the towing vehicle a firmer ride when not towing.

There are a number of suspension aids available and advice should be sought on which to use and how to fit. It is important to ensure that the caravan is towed either level or slightly nose down.

If you have any doubts about the suitability of your tow bar for towing a caravan consult the tow bar manufacturer.

⚠ WARNING: Do not exceed the following masses:

- Gross Vehicle Mass (G.V.M. on car plate).
- Maximum Technically Permissible Laden Mass (M.T.P.L.M.) on the caravan.
- Gross Vehicle Combination Mass (Train Weight) (G.V.C.M. on car plate).
- Maximum Permissible Towing Mass.
- Vertical Static Load on the caravan coupling (nose weight).
- Maximum Vertical Load on the car tow ball as specified by towing vehicle manufacturer (nose weight).
- Driving licence limitations

5.6 Measurement of nose weight

Nose weight may be measured using a proprietary brand of nose weight indicator. Such equipment is obtainable at your Caravan Dealer.

ⓘ Note: These indicators have a varying tolerance level and may not be accurate. Another simple method is to use bathroom scales under the coupling head with a piece of wood, fitted between the coupling head and the scales, of such length that the caravan floor is horizontal with the jockey wheel raised clear of the ground. (Fig. A)

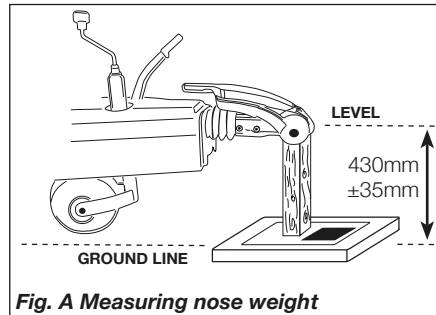

Fig. A Measuring nose weight

Nose weight can be adjusted simply by distribution of weights in the caravan.

Always lower jockey wheel before entering the caravan and then raise before measuring again. (See Loading).

ⓘ Note: Fitting cycles to the rack will alter the nose weight. Take particular care if you do not always carry your cycles, to rebalance the caravan before each journey.

ⓘ Note: The height of the towball on the towing vehicle, when laden, is also critical. To comply with UNECE regulation R55 the towing vehicle tow ball should be between 350mm and 420mm from the ground.

⚠ WARNING: Do not lift the coupling head by hand when hitching the caravan to the car. Always raise and lower the coupling head by winding the handle on the jockey wheel up and down.

TOWING STABILITY / AL-KO ATC TRAILER CONTROL SYSTEM

5.7 Towing stability

All our models are of a well-balanced design and should be exceptionally good towers. All models apart from the Sprite range (Diamond pack option) and Basecamp have an AL-KO stabiliser fitted as standard. (See Al-Ko chassis handbook for more details)

The common causes of poor stability include:

- Worn springs or loose spring fixings on the towing vehicle.
- Towing vehicle springs too soft.
- Insufficient nose weight.
- Nose of caravan is towing too high or too low.
- Unsuitable towing vehicle

Snaking:

This is a term used to denote an unstable car and caravan combination where the caravan 'weaves' from side to side often causing a similar swaying movement in the car itself.

Causes:

- Unsuitable or unbalanced outfit.
- Incorrect loading or weight distribution.
- Excessive speed especially downhill.
- Side winds.
- Overtaking.
- Being overtaken by a large fast moving vehicle.
- Erratic driving.
- Incorrect tyre pressures, car and caravan
- Incorrect vehicle tow ball height
- Worn stabiliser pads or tow ball

Cures:

- Cases of persistent snaking can be alleviated by the use of a stabiliser.
- If you do find your outfit snaking, try to keep the steering wheel in a central position as far as possible, decelerate and avoid braking if possible.

5.8 AL-KO ATC Trailer control system

(where fitted)

Please refer to the AL-KO ATC handbook supplied with your caravan for more details and fault finding

AL-KO ATC is an electronic, emergency Control system for caravans and trailers. It automatically recognises critical swaying motions and applies the caravan brakes accordingly to regain control of the caravan and car.

AL-KO ATC is a passive safety product that activates the braking system on the caravan in unsafe driving conditions. The driver has a responsibility under law to ensure that the elements of towing safety are met, including driving within the legal speed limit, consideration of road, weather and other traffic conditions, correct loading and coupling of the caravan.

In order for the ATC to function correctly the electrical connection between the towing vehicle and caravan must be in good working order.

Upon connection of the 13 pin connector the ATC will carry out an initial self-test and the LED light on the 'A' frame cover will light up RED. During the self-test, the sound of the push rod moving inside ATC can be heard. When the self-test is complete, the LED will turn GREEN or flashing GREEN to signal that ATC is active.

ATC LED light



TOW BALL / HITCH HEAD
HITCHING UP

⚠ WARNING: If the LED does not change to green, then ATC is not functioning correctly. Do not tow the caravan until it has been rectified. Please refer to the AL-KO ATC handbook for more details and fault finding

📌 Note: Please be aware your ATC is 'live' all of the time your 13 pin connection is made. If the car and caravan are stood for a long period of time (eg. ferry crossing) the ATC will continue to draw power from your battery.

5.9 Tow ball / Hitch head

Tow Ball

The tow ball should be clean, free of rust and undamaged and not excessively worn.

If the caravan has an AL-KO AK161 type hitch head (Basecamp and standard spec Sprite) then the tow ball should be lightly greased

If the caravan is fitted with an AL-KO AKS 3004 hitch head then the tow ball must be completely free of grease to avoid contaminating the friction pads. This type of hitch head is designed to be used with a swan neck, fixed or detachable tow ball. If you use a 'bolt on type' tow ball you may need to replace your tow ball with a special extended neck tow ball.

If you have a bolt on type tow ball you should ask your dealer to check clearance around the tow ball to allow for the stabiliser to articulate.

The AL-KO extended neck tow ball (available from your dealer) is approved to UN ECE R55.

🚫 CAUTION: Failure to provide enough clearance around the tow ball may invalidate your stabiliser warranty.

Hitch Head Capacity

The maximum vertical static load which can be put upon the hitch head when connected is 100 kg. Please refer to the technical data in your handbook. (But see also tow vehicle manufacturer's weight limits on tow ball loading.)

5.10 Hitching up

An assistant can help in the hitching operation by standing on the left hand side of the drawbar (facing rear of car) and extending an arm horizontally to indicate position of the coupling. When reversing aim the tow ball of the car directly at the caravan drawbar. Remove tow ball cover and keep in car.

Adjust the jockey wheel to ensure the hitch head is high enough to slide over the tow ball

AK161 TYPE HITCH HEAD

AK161 Type Hitch head

SAFETY 1

Open position

The hand grip points diagonally upwards and indicates to the operator that it is open.



SOFT TOUCH GRIP

(AL-KO registered design)

A soft and therefore adhesive plastic mixture is used in the red area of the hand grip. In addition, the projection on the end of the hand grip serves as an anti-slip protection.



When the towball is not yet fully inserted a red section is displayed.

SAFETY 2

Closed position

The towball is fully inserted and has released the securing lever. (Important! Legally prescribed minimum imposed load is necessary). Only now does the hand grip take up the horizontal position and indicate to the operator that a secure connection has been created. The unit is now ready for towing.



SAFETY 3

Display for correct hitching

In the closed position, the green safety display is pushed out by the ball on the towing vehicle, and is therefore visible. Once again, it signals to the operator that the trailer is securely connected to the towing vehicle. The journey may now start.

Securing lever for flawless hitching

Fig. A

Open the locking mechanism by pulling the coupling handle upward in the direction of the arrow (Fig.A safety 1). The handle will remain in the open position until the hitch head is positioned onto the towball.

Release the caravan handbrake and manoeuvre the hitch head over the **greased towball** and re-apply the handbrake. Using the jockey wheel winding handle, lower the hitch head carefully onto the towball. The pressure of the towball within the hitch head will release the locking tongue with an audible click and the coupling handle should drop down. For safety check that the coupling handle is fully down by pushing the handle down manually. When the hitch head is correctly coupled to the tow ball the green collar of the locking display button will be visible. (Fig A Safety 3). If the green collar is not visible it is not safe to tow the caravan. Contact your dealer for advice.



AKS 3004 Hitch head**Fig A**

Release the caravan handbrake and manoeuvre the hitch head over the ungreased tow ball and re-apply the handbrake. Lift forward the large stabiliser handle (Fig. A) lift forward the exposed smaller handle (Fig. A) until it clicks up.

**Fig. B**

Adjust jockey wheel to lower the hitch head onto the ball. A click indicates it is fully engaged. Ensure the smaller handle has returned to its free position.

Firmly push down the large stabiliser handle to engage the friction pads. (Fig B)

The hitch head is fitted with a visual indicator to show whether or not it is properly connected to the tow ball. A green band will show immediately below the red indicator button on the hitch head when a proper connection has been made. (See Fig. C)

⚠ WARNING: If the green band is not visible it is not safe to tow the caravan. Contact your dealer for advice.

**Fig. C**

Ensure that the jockey wheel is fully wound up and properly located in the slots in the jockey wheel tube, then release the clamp handle, lift the whole unit as high as possible ensuring the wheel is pointing directly backwards and retighten the clamp handle.

⚠ CAUTION: Ensure jockey wheel locates in the recess provided. Carelessness could result in damage to the A-frame cover.

⚠ WARNING: If the green band is showing when the hitch head is not connected to the tow ball (figure C) there is a fault - contact your Dealer. Do not tow the caravan.

BREAKAWAY CABLES

Breakaway Cables

UK law requires that all caravans are fitted with a safety device to provide protection in the unlikely event of separation of the main coupling while in motion. A device referred to as a 'breakaway cable' fulfils this requirement and when fitted on your caravan its use is mandatory.

Purpose

To apply the caravans brakes if it becomes separated from its towing vehicle. Having done this, the cable assembly is designed to part allowing the caravan to come to a halt away from the towing vehicle.

Construction

A thin steel cable with a red plastic coating fitted with a means of attachment for connection to the towing vehicle. Located directly beneath the coupling head.

Operation

In the event of the main coupling of the caravan separating from the towing vehicle, the cable should be able to pull tight, without any hindrance, engaging the caravan brakes.

The breakaway cable should not become taut during normal driving.

Correct procedure for use

Regularly check the cable and clip for damage. If in doubt contact your Swift Group dealer.

Make sure the cable runs as straight as possible and goes through the cable guide fitted underneath the caravan coupling head.

Determine whether or not the towing vehicle tow bar has a designated attachment point (i.e. a part specifically designated for a breakaway cable).

Where a point is designated on the towbar:

- Either pass the cable through the attachment point and clip it back on itself (Fig 1) or
- Attach it directly to the designated point (Fig 2).

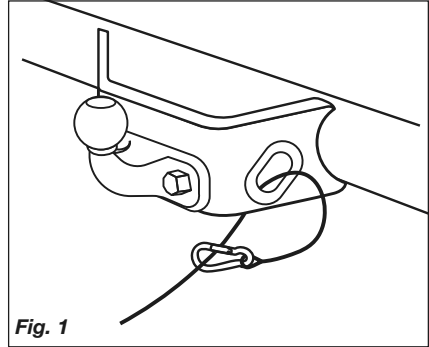

Fig. 1

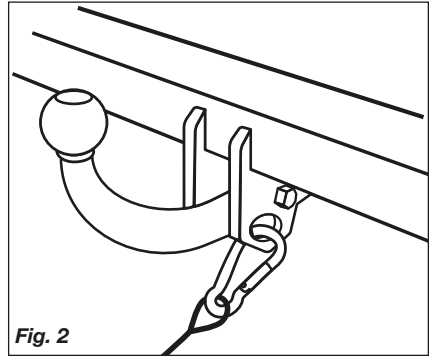

Fig. 2

Where there is no designated attachment point on the tow bar loop the cable around the neck of the tow ball in a single loop only. See figure 3a and 3b on the next page.

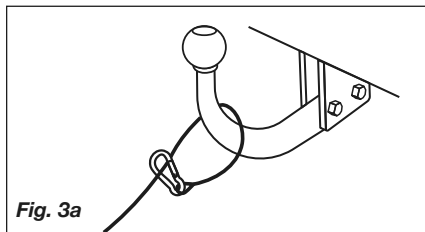

Fig. 3a

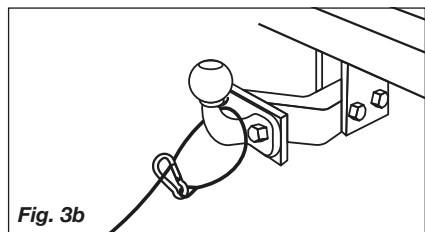

Fig. 3b

In some instances it may be possible to attach the cable assembly either to a permanent part of the tow bar structure, as long as this meets the approval of the tow bar manufacturer/supplier, or to an accessory sold for the specific purpose of breakaway cable attachment.

CAUTION: For vehicles fitted with detachable tow bars, guidance must be sought from the tow bar manufacture/supplier on the correct method for attaching the breakaway cable.

When the breakaway cable is attached it must not snag in use on the caravan coupling head, jockey wheel or any accessories, e.g. a stabiliser, bumper shield, cycle carrier, etc. There should also be sufficient slack in the cable to allow the towing vehicle and caravan to articulate fully without applying tension to the cable which could otherwise cause the caravan brakes to be inadvertently applied.

The cable must not be allowed to drag on the ground. If there is too much slack, the cable might drag on the ground and be weakened so that it has insufficient strength to apply the brakes in the event of the caravan becoming detached when in motion. Excess slack may also lead to the cable being caught on an obstacle when in motion, leading to inadvertent application of the caravan brakes.

Care must be also taken to ensure that the cable cannot be entangled with the electrical cables.

Caravan 13 Pin Connection -

All Swift caravans are supplied with a 13 pin plug to connect to the tow car. The 13 pin plug has an inner ring assembly that is independent from the outer body. Fig 1

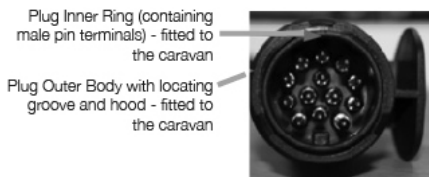

Fig. 1 - 13 Pin Plug

Under normal circumstances the inner ring and the outer body will be locked in one position (see fig 2).



Fig. 2 - Correct Alignment



Fig. 3 - Socket body (containing female socket terminals) fitted to the car

13 PIN CONNECTION

When the plug is first inserted in the socket body (Fig 3) ensure that the locating protrusion (key) in the plug matches the groove (keyway) in the socket body. The outer body can then be rotated a full 90 degrees clockwise until a click is felt or heard, at this point the cover flap can be allowed to fall over the circular surface of the plug top. (Fig 4 & 5)



Fig. 4



Fig. 5

To remove the plug it is important to rotate the outer body a full 90 degrees anti-clockwise, again until a click is heard or felt before withdrawing the plug from the socket. This will ensure that the inner and outer parts of the plug are returned to a locked condition.

⚠ CAUTION: If the connector is not fully rotated anti-clockwise prior to removing it from the socket it is possible that the inner ring will become 'floating' and may result in a condition where the protrusion will be incorrectly aligned (see fig 6 & 7).



Incorrect alignment

Fig. 6



Incorrect alignment

Fig. 7

If this situation does occur then it can be corrected by inserting the edge of the protrusion on the plug into the groove in the socket (see Fig 8) and rotating the plug body anti-clockwise until a click is felt. This process will re-establish the lock between the inner and outer parts allowing the correct insertion of the plug into the socket.

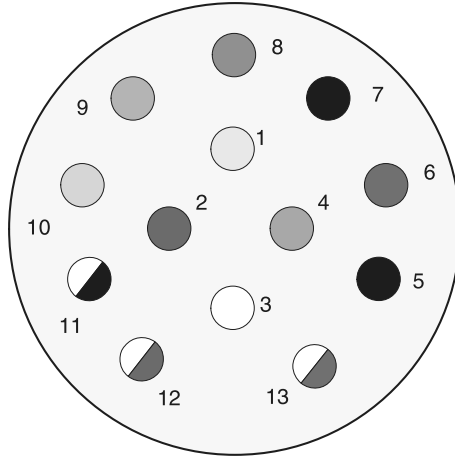

Fig. 8

ⓘ Note: Customers should be aware that the tow bar and tow car electrical socket will be checked as part of the standard MOT regulations, under directive 2014/45/EU. Inappropriate repair or modification to either maybe deemed a failure of the vehicle if it is likely to affect the road worthiness of the vehicle.

13 Pin socket

Please be aware that some car manufacturers and towbar manufacturers do not wire up all 13 pins as standard, unless requested.



11446 Plug Connector viewed
from cable entry on plug

Pin No	Core Colour	Core Size	Function
1	Yellow	1.5	Left Hand Indicator Light
2	Blue	1.5	Rear Fog Warning Light(s)
3	White	2.5	Earth for pins 1 - 8
4	Green	1.5	Right Hand Indicator Light
5	Brown	1.5	Right Hand Tail Light
6	Red	1.5	Brake Lights
7	Black	1.5	Left Hand Tail Light
8	Pink	1.5	Reverse Light(s)
9	Orange	2.5	Car +ve
10	Slate (Grey)	2.5	Fridge +ve
11	White/Black	2.5	Earth for pin 10
12	White/Blue	1.5	Not Yet Allocated
13	White/Red	2.5	Earth for pin 9

TOW CAR ELECTRICS / ROAD LIGHTING MIRRORS / PRE-TOW CHECKLIST

Tow Car Electrics

In all cases, The Swift Group assumes that the tow car harness and electrics have been fitted with the specific requirement of connection to a caravan, which may contain AL-KO trailer control (ATC), a 12V powered fridge and charging circuits.

Most modern retro-fit tow bars contain a relay, located somewhere within the boot of the tow car, which may have a selectable power output for the fridge supply.

If a customer is experiencing issues with the fridge supply it is possible the relay requires adjustment and they should contact their tow vehicle electrics installer or an auto electrician to verify the installation.

Road Lighting

Your caravan is fitted with LED road lighting, including the directional indicators and stop lamps. LEDs consume very little power, offer excellent light output and longevity when compared to traditional tungsten bulbs.

Some more advanced tow cars are fitted with Vehicle Light Monitoring Systems (VLM), where the car monitors the condition of the trailer/caravan road lights and advises the driver of any bulb failures. To do this, some tow cars expect to see a load on the caravan lighting circuit similar to a tungsten bulb while others may send a pulse of energy to each light to confirm that the resistance of a bulb is present.

The result of the above is that some tow cars may incorrectly advise the driver of a bulb failure, due to the use of LED lights while others may flash or pulse the lights during use.

Recognising this, The Swift Group have developed an additional towing fuse box, which when connected to the existing towing fuse box and is used to assist the tow car in recognising the VLM System. Depending on the type of car and system used the fuse box maybe model specific.

The secondary fuse box is chargeable and available through any Swift Group Dealer.

Mirrors

Towing mirrors are mandatory in the UK. It is essential that exterior towing mirrors are fitted. This is mandatory and drivers can face instant fines if extension mirrors are not fitted.

⚠ WARNING: Any rear view mirror must not project more than 250 mm outside:

- The width of the caravan when being towed.
- The width of the towing vehicle when driven solo.

ⓘ Note: Any rear view mirror fitted shall be 'E' marked and cover the field of view as stipulated by type approval requirements ECE Regulation 46 or Regulation 33 of the Road Vehicles (Construction & Use Regulation 1986).

Pre-Tow Check List

- Check gas locker, battery locker and cassette toilet doors are secure.
- Check wheel nuts, tyre pressures and tyre conditions.
- Fully raise all four corner steadies. (Fig. D).



Fig. D

- Pick up any levelling pads or levelling boards.
- Check windows/roof lights/vents are securely closed.
- Ensure television aerial is lowered (where applicable).
- Switch off gas supply unless using en route heating. (See gas in services section) and change over fridge to 12v electricity if required.
- Lock the caravan exterior door.
- Check all car and caravan road lights are working.

- Check round the caravan for anything left behind.
- Release caravan handbrake
- With the aid of an assistant adjust the rear view mirrors to give a clear view down either side of the caravan whilst sitting in the driver's seat.
- Check that the 13 pin connector is inserted correctly and ensuring there is enough loose cable for cornering, but also ensuring that it can't drag on the ground.
- Check the AL-KO ATC light is green where fitted
- Check the function, cleanliness and condition of the road lights. Lenses and reflectors must be in good condition

CAUTION: Do not cause any road lighting to be obstructed by the addition of any options or accessories to your caravan.

CAUTION: If a towing cover is fitted, care should be taken not to obscure lights, reflectors and protect against rubbing or damaging the bodywork.

5.11 Towing the caravan

Speed limits

Single carriageway: 50mph

Motorways (including dual carriageways):
60mph

Moving off

Let the clutch in smoothly. Allow more engine speed to produce the power to move the additional weight of the caravan.

Reduce wear and tear on clutch and transmission by taking extra care by changing gears smoothly and trying not to jerk the clutch.

Caravan handling

Allow for caravan being wider than car.

Do not bump kerb with caravan wheels.

When passing other vehicles allow more than the normal clearance for driving solo.

Allow longer to build up speed to pass.

Allow for the outfit being twice its normal length.

Do not suddenly swing out.

Carry out all manoeuvres as smoothly as possible.

Use nearside wing mirror to check caravan has cleared when overtaking.

CAUTION: Take care not to foul or ground caravan chassis whilst traversing ramps or other obstacles.

Motorway driving

Important points

- Caravans may not be towed in the outside lane of a three or four lane motorway.
- Reduce Speed:
 - a. In high or cross winds
 - b. Downhill
 - c. In poor visibility
- High sided vehicles cause air buffeting so extra care must be taken when passing or being passed. As much space as possible should be given.

ARRIVAL ON SITE

Reversing

When the towing vehicle is reversing, the overrun device shaft is pushing in, applying the brakes via the overrun lever, brake rod system, bowden cables and the expander mechanism.

The backwards rotation of the brake drum causes the secondary brake shoe to collapse cancelling out the braking effect, allowing the caravan to move backwards. At the same time the transmission lever swings back and compensates for the entire travel.

When reversing up a slope or on a loose surface the brakes may apply themselves. Correct maintenance and set up of the brakes will help prevent this. Incorrect adjustment of the wheel brakes or linkages will result in making reversing difficult.

Proficiency at reversing can only be achieved with practice and should be first attempted in a large open area (Fig. A).

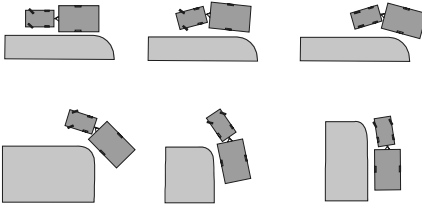

Fig. A - Reversing

5.12 Arrival on site

Note: Check and observe site regulations.

Manoeuvring your caravan by hand

CAUTION: Care must be taken when manoeuvring your caravan into position. Pressure placed on unsupported parts of front and rear GRP panels may cause surface damage/ cracks to appear. Use the grab handles provided.

Selecting a pitch

Do not pitch in such a position that your outfit will obstruct others coming in.

Try to choose an area which is dry, reasonably level and preferably with a hard base.

If you have no alternative but to pitch on a slope ensure that, for when you leave, you are facing down the slope.

It is good practice to chock the wheels of the caravan when parked on a slope even though the caravan brakes are applied.

Levelling the caravan

Levelling must be carried out in both directions in order for the refrigerator and other equipment to function correctly. This should be done before unhitching the caravan.

Use of a spirit level to check that the desired result has been achieved

Levelling boards (Fig. B) or proprietary levellers purchased from your caravan dealer can be used to raise one side of the caravan by driving or reversing the caravan onto the boards. Apply the handbrake and chock the wheels.



Fig. B - Levelling Board

Level the caravan front to back by using the jockey wheel winding handle to raise or lower the front of the caravan.

Unhitching

Before applying the handbrake ensure the hitch is fully extended and not compressed behind the tow vehicle otherwise the hitch will not release from the tow ball.

Apply the caravan handbrake. Lower the jockey wheel to the ground.

Disconnect the breakaway cable and road 13 pin lighting plug by rotating anti-clockwise through 90 degrees. See 13 pin connection in section 4.10.

AK 161



Lift the coupling handle to release the locking tongue, whilst simultaneously winding down the jockey wheel to lift the caravan hitch head clear of the tow ball.

AKS 3004



Release the stabiliser by lifting the large handle. Then lift the exposed small handle forward to release the locking tongue, whilst simultaneously winding down the jockey wheel to lift the caravan hitch head clear of the tow ball.

Exterior door

To prevent distortion of the body, the caravan must always be correctly sited and levelled. Failure to site the caravan correctly may prevent the exterior door from closing properly.

Corner Steadies

Lower the corner steadies until they are in firm contact with the ground.

CAUTION: DO NOT use the steadies as a jack they are only a means of stabilising the caravan.

Levelling pads or boards should be used under the steadies where the ground is soft or uneven or when the corner steadies are too short to reach the ground due to the levellers under the wheels

In extreme cases where it is necessary to raise a wheel off the ground for levelling purposes, further adequate support should be applied so that the steadies do not take any undue strain.

5.13 Tyres and wheels

Tyres

It is illegal to mix tyres of a different construction on the same axle.

Periodically tyres should be rotated to equalise wear in the same manner as car tyres.

Tread depth

Pay special attention to the amount of tread remaining on your tyres, and measure them regularly. Always replace tyres before they reach the minimum legal limit of 1.6mm.

Pressures

Note: Sales literature/ Technical Handbooks publish recommended tyre pressures for the MTPLM only (fully laden condition). It is not possible to publish tyre pressures for any other load condition other than the MTPLM.

Note: Although the caravan may be fitted with the same type of tyre as the towing vehicle, the pressures specified are different. All charts show values for cars and are therefore not applicable for caravans.

Pressures displayed on tyre walls apply **ONLY** in North America and Canada.

The caravan manufacturer's plate (fixed adjacent to exterior door) and Technical handbook contains information about caravan loading and the required adjustments to tyre pressures, which should be followed for safety (these pressures relate only to the tyres originally fitted to the caravan). Tyre pressures should always be checked and corrected prior to each journey. It is vital that tyre pressures are maintained at the levels recommended by the manufacturer to ensure maximum tyre life, safety and handling characteristics.

Please also remember to check your spare tyre pressure as it can be overlooked. The spare wheel can be either in the front gas locker compartment, on a spare wheel carrier underneath the caravan or in the fixed double bed area depending on layout and specification.

Over or under-inflating tyres is likely to seriously impair their performance and may prejudice the safe use of the vehicle. Over-inflation increases overall tyre diameter, decreases the amount of tread in contact with the road, decreases sidewall flexibility and affects road-adhesion.

Under-inflation decreases overall tyre diameter, increases sidewall flexing, generates higher tyre operating temperatures and difficult vehicle handling characteristics. Running an under-inflated tyre may cause premature tyre failure.

Both over and under-inflation adversely affect tyre life.

Treads

Keep tyre treads clean of stones and other foreign bodies, and check regularly for damage to the tread and sidewalls. It is vitally important that any damage is checked out by a tyre expert and any necessary repairs or replacements are carried out immediately.

Tyre valves

Check tyre valves carefully. Ensure the caps are in place free from dirt/ debris and that there is no evidence of cracking or damage to the valve stem.

Tyre aging

Rubber compounds used in tyres contain chemicals that help to slow down the natural aging process of untreated rubber. However, tyres do deteriorate with age, which increases the risk of tyre failure, and there are many ways in which this can be spotted:

- Cracking/crazing on the side wall of the tyre, caused by its flexing
- Distortion of tyre tread
- Deformation of the carcass of the tyre

There will also be a deterioration of the ride quality caused by vibrations through the tyre. This may signify the tyres performance has been affected by age and should be investigated as soon as possible.

Note: It is recommended that tyres are replaced after 5 years from the date of first inflation. The date of first inflation is normally within a few days of the date of manufacture of the vehicle they are fitted to, and this date can be determined from the gas and / or electrical certificate supplied with the caravan.

We recommend that tyres that are over 5 years old (from first inflation) are inspected and passed as fit for use by a qualified technician. It is possible that in the event of a tyre failure, an insurer may not cover any losses incurred if the tyre is over 5 years (from first inflation) and was not inspected no more than 12 months prior to the incident.

Tyres that display signs of aging should be removed and not put to further use.

The effects of aging can be brought about prematurely in several conditions. Tyres fitted as spare wheels may age prematurely. If tyres on caravans are not in regular use they should be inspected before every journey, several cleaning products may also harm the chemicals in the rubber. However, the age of a tyre will affect its safety and increase the risk of failure, and you should inspect tyres for the signs of aging regularly.

Note: The use of some motor movers can damage or increase wear on the tyres prematurely.

The tyre law

Wheels

Caravan wheel bolts supplied with your caravan should be tightened to a torque of 88Nm (65lb/ft) on steel wheels or 130Nm (96lb/ft) on alloy wheels and should be checked with the use of a torque wrench regularly. Only use a spare wheel and tyre of the type and size provided with your caravan.

Note: Please remember to check the wheel bolt torque setting regularly.

Wheel rims

Three sizes of wheel rims are used 5.5J x 14, 6J x 15, and 6.5J x 16. The rim sizes are the same for both steel and alloy rim, incorporating a double safety hump which conforms to European safety standards. Check the size on your caravan before replacing a rim.

CHANGING A WHEEL

5.14 Changing a wheel

⚠WARNING: Only jack up your caravan when it is coupled up to the car with its handbrake applied and in 1st gear (engine off).

1. When changing a wheel leave caravan hitched to towing vehicle and ensure that the caravan and towing vehicle handbrakes are applied.
2. Lower corner steadies (as safety measure) on the side that is being jacked up.
3. Remove wheel trims (if fitted).
4. Use wheel brace to slacken off wheel nuts on the wheel to be changed.
5. Position jack under the axle at the appropriate jacking point. (See Fig. B, page 51)
6. Jack up the caravan until the wheel for removal is just off the ground.
7. Remove the wheel nuts and remove the wheel.
8. Fit spare wheel and reverse the above procedure. Ensure clean, dry mating surfaces and clean, dry bolt sealing areas.
9. Ensure the spare wheel is free from damage and distortion
10. Tighten all five bolts, to 88Nm (65lb/ft) for steel wheels or 130Nm (96lb/ft) for alloy wheels using a torque wrench or have checked as soon as possible.
11. Ensure the correct wheel fixings are used, as supplied with your caravan.

⚠WARNING: When a wheel has been removed and replaced the torque of the wheel nuts should be re-checked after approximately 30 miles.

Wheel bolt tightening

When refitting a wheel it is ESSENTIAL that the wheel bolts are tightened to the recommended torque figure and in the correct sequence.

ⓘNote: Only use a suitable wheel brace to loosen and tighten the wheel bolts. Do not use the corner steady brace for this application.

The sequence necessary to correctly carry out this work on a 5 stud wheel is as shown in Fig. A.

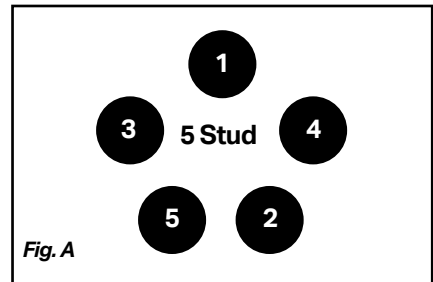

Please note the correct torque settings.

Jacking points

ⓘNote: Al-Ko jacking brackets and jacks are not standard on all models. If not fitted they can be obtained from your supplying dealer or direct from Al-Ko

⚠WARNING: Only jack up your caravan when it is coupled up to the car with its handbrake applied and in 1st gear (engine off).

Ensure that the jack is located in the correct position, i.e. on the jacking bracket on the chassis for the AL-KO side mounted jack (Fig.B). Alternatively the reinforced axle mounting plate can be used but the chassis member itself **MUST NEVER** be used as a jacking point.



Fig. B - Side Lift Jack

All caravans are provided with the facility to fit AL-KO side jacking points although a scissor, trolley or bottle jack may be used. Ensure the lifting capacity of your jack is suitable for your caravan.

The AL-KO side lift jack

The AL-KO Side Lift Jack has been specifically developed to aid the often difficult process of changing a wheel on caravans.

It is suitable for fitment to the AL-KO chassis, located in the pre-drilled holes in the longitudinal members.

Note: The fitment of some aftermarket motor movers may inhibit the use of the AL-KO jacking system. It is the responsibility of the motor mover fitter to provide a suitable alternative

Please contact AL-KO for an alternative jacking location if one has not been provided

5.15 Miscellaneous equipment

Awnings - Can consist of just a simple top sheet but may extend to a five sided frame tent attached to the side of the caravan.

Fire blanket - approved to BS 6575 is ideal for dealing with 'fat pan' fires.

Fire extinguisher - It is strongly recommended that a fire extinguisher is carried in the caravan. (For suitable types see Safety).

Gas Bottles - Bottled LPG (Liquefied Petroleum Gas) is the most convenient portable source of fuel. Ideally two bottles are required for a constant supply. An initial deposit is payable on each cylinder. We recommend the use of 6kg Calor Light Propane bottles. One connected for use and one for storage only unless a Duo Comfort or Duo Control regulator is fitted. (For detailed information see Services - Gas).

Jack - A suitable jack is essential (screw, scissor, side mounted or air jack type). Many car jacks are unsuitable. Ensure the lifting capacity of the jack is suitable for your caravan.

Levellers - Levellers help level the caravan from side to side before unhitching. Proprietary products can be purchased from your caravan dealer and need to be positioned as indicated by a spirit level.

Spare Wheel - It is always advisable to carry a spare wheel with your caravan.

Spirit Level - A spirit level is extremely useful when siting the caravan. There are also many free to download levelling applications available on compatible mobile devices

Stabiliser - Stabilisers help to dampen the side to side movement of the caravan.

Torque Wrench - A torque wrench is the only way that the exact recommended torque can be achieved for wheel nuts and bolts.

Tow Bar - Always obtain one manufactured by the tow vehicle manufacturer or a reputable tow bar manufacturer ensuring that it complies with the relevant standards.

Any light passenger vehicle registered in the UK on or after August 1st 1998 will require a type approved tow bar and tow ball (to 94/20/EC or UN ECE R55). Failure to fit a homologated tow bar and tow ball could result in a prosecution

MISCELLANEOUS EQUIPMENT

and invalidation of your insurance cover. Always check with your car manufacturer or tow bar manufacturer if in doubt.

① Note: The height of the towball on the towing vehicle, when laden, is also critical. To comply with UNECE regulation R55 the towing vehicle tow ball should be between 350mm and 420mm from the ground.

Wooden Blocks - Wooden blocks typically 25cm square and 2cm thick are ideal for placing under corner steadies and jockey wheel when the ground is uneven or soft.

Water Containers - Two containers are required, one to carry fresh water to the caravan and one for waste water, which needs to be disposed of properly. Several types are available including jerry cans, Aquarolls, wastemaster, etc .

13 Pin Connector – This is the electrical socket fitted to the car to accept the corresponding plug from the caravan that energises the road lights and caravan auxiliary circuits.

12 Volt Battery - A deep cycling, heavy duty rechargeable leisure type battery should be purchased to provide back-up power for lights and other electrical appliances. (See Battery). The maximum battery size that can be fitted is 225mm high, (including terminals) x 175mm deep x 353mm wide.

① Note: Check first that the battery will fit within the battery box and can be secured before purchasing.

⚠ WARNING: Your caravan dealer should be consulted if additional equipment is to be fitted as strong points may or may not be provided in the design.

Caravan motor movers

If thinking of installing a caravan mover as an aftermarket fit it is advisable to consult your dealer first. It may not be possible to fit a motor mover if shock absorbers are fitted and it may impede the AL-KO jacking point. (See Al-Ko side lift jack in section 5.14)

The design and fitment of a caravan motor mover shall be in accordance with the NCC Code of Practice 305 and you should ensure you receive a signed installation certificate of compliance from the installer.

① Note: Failure to obtain an installation certificate may invalidate your warranty.

Depending on specification, the wiring in the caravan battery box may feature connections suitable for use with an aftermarket motor mover installation. When fitted, this will feature an isolation switch, fusing, and heavy duty wiring, terminated in two connection points within the caravan battery box.

Please note that some installers will fit the isolation switch for the mover in the external TV point located in the battery box (model specific), resulting in the loss of this functionality.

① Note: Fitting additional equipment, such as a motor mover will reduce the caravan allowable payload.

① Note: The fitting of a motor mover may require a larger capacity battery fitting.

Caravan theft	54
Caravan insurance	54
CRiS registration and VIN chip	54
Additional Security	55
Mobile alarm system	55
Swift command tracker	55
AL-KO secure immobiliser	56

Your Swift caravan has a number of security features to deter thieves and to help prevent the theft of your caravan.

Caravan theft

The theft of a caravan can occur in the most unlikely circumstances; from a motorway service area, even from an owner's driveway.

Secure all windows and doors when your caravan is unoccupied even if only for a short length of time.

Caravan insurance

It is recommended that the caravan and its contents should be insured against theft. It is essential to check with your car insurance company to ensure you are covered when towing your caravan.

6.1 CRiS registration and VIN chip

Caravan Registration

Your caravan has been security marked and recorded under the Caravan Registration and Identification Scheme that is recognised by the Caravan Industry.

Shortly after purchasing this caravan you should receive your Touring Caravan Registration Document. It will be sent by post to your home address.

Your Touring Caravan Registration Document will include a 17 character VIN (Vehicle Identification Number), shown in the top right hand corner. This 17 character VIN will be permanently marked onto the off side caravan chassis drawbar member. It is also stated on the manufacturer's weight plate next to the doorway.

Make a note of this number in the space provided at the front of this handbook and make a separate note of the number to keep safe at home.

To protect yourself and your touring caravan, never leave the Registration Document in the caravan. For security reasons keep it in a safe place.

If you sell the caravan please follow the instructions on the Touring Caravan Registration Document.

If you do not receive a Touring Caravan Registration Document, lose it, or any of the details recorded are incorrect, please contact: CRiS, Avonbridge House, Bath Road, Chippenham, Wiltshire, SN15 2BB or Tel 0203 282 1000.

VIN Chip Caravan Identification

The caravan's unique 17 character VIN will be incorporated into VIN Chip tamper evident labels; the master VIN Chip label is situated on the front near side window to aid police checking, another in the gas locker and a maximum of 10 placed on the inside of the windows (with the exception of opaque windows).

Three electronic RFID chips containing the individual identity of your caravan are concealed within the caravan and can only be read by using a specially programmed RFID scanner.

Your local police can obtain the use of a CRiS VIN Chip scanner by contacting CRiS on Tel 0203 282 1000.

For help, support and advice Contact CRiS:

NCC CRiS Ltd

PO Box 445

Aldershot

GU11 9SF

Tel 0203 282 1000

www.cris.co.uk

Opening Hours: Monday - Friday 8am to 8pm

Saturday 9am to 5pm

Sunday 10am to 5pm

6.2 Additional Security

Consider fitting any device which might deter or prevent intrusion by thieves.

A hitch lock cover prevents towing of the caravan.

A wheel lock prevents towing of the caravan and removal of the wheel (some models are provided with an AL-KO Secure device).

Customers are advised to identify their caravan with a method for subsequent identification if other forms of identification have been altered or removed.

Free crime prevention advice about securing your caravan, protecting your valuables, property marking, either at home or whilst on site, can be obtained from the Crime Prevention Officer through your local Police Station.

6.3 Mobile alarm system

Depending on specification, your caravan may be fitted with a Sargent Stinger Alarm System. Please read the instructions for the alarm, which are available at: <https://sargentltd.co.uk/tech-support/article/Alarm-Manuals/21>



If you are unable to view the documents on line, please contact the supplier, your dealer or Swift for an electronic or paper copy.

6.4 Swift Command Tracker

by Sargent

A Swift Command Tracker is built in to your vehicle and forms part of the Swift Command system. The unit is Thatcham Category 6 certified and is monitored by an approved monitoring centre which operates 24 hours a day 7 days a week and provides European coverage and direct police liaison.

This system is ready for use, all you need to do is purchase a tracking subscription by visiting www.swiftcommand.co.uk or calling Sargent on 01482 881655.

The subscription cost is £95 per year including VAT.

For more information please visit www.swiftcommand.co.uk

Operation

The Swift Command Tracker is easy to operate as it is controlled by the vehicle systems.

In a caravan the tracker is armed when the Stinger Alarm System is armed. It is disarmed when the alarm is disarmed.

If the caravan doesn't have an alarm system fitted, a simple numeric keypad is used to arm / disarm the tracker. Enter your code followed by the ON button to arm the tracker.

Enter your code followed by the OFF button to disarm the tracker.

Event of a Theft

If the vehicle is moved whilst the tracker is armed the geo-fence monitoring will trigger a theft event.

In addition to the above, in a caravan with the Stinger Alarm System fitted, if the alarm is triggered by internal movement or caravan tilting the alarm monitoring will also trigger a theft event.

The monitoring station will now contact you to confirm the theft or false alarm. You will be required to confirm your identity against the information you provided when you subscribed.

If a genuine theft is confirmed the monitoring station will liaise with the police and keep you informed of progress.

AL-KO SECURE IMMOBILISER

Note: During a theft event to comply with legislation you will not be able to manually locate your vehicle using the Swift Command locate feature.

Contact

Before contacting any of the following please ensure you know your caravan serial number. For caravans this is the last 10 digits of the CRIS number (e.g. SWL1034567).

The Swift Command Tracker monitoring station can be contacted on 0345 6027302. The stations operates 24 hours a day 7 days a week.

Sargent customer support can be contacted on 01482 678981 or via support@swiftcommand.co.uk

Telephone lines are manned during normal office hours.

Swift customer support can be contacted on 01482 875740 during normal office hours.

Precautions

The Swift Command Tracker monitors the leisure battery supply and if the voltage falls below a set level or the battery is removed this will trigger a fault event.

If you plan to remove your battery for maintenance or external charging please contact the monitoring station BEFORE removing the battery.

If you lose an alarm key fob you need to contact Sargent for a replacement and follow their instructions to remove the 'lost' fob from the system.

6.5 AL-KO secure immobiliser

The AL-KO Secure immobiliser is fitted as standard on some models, optional on others. This is specific to alloy wheels and not compatible with steel wheels. The AL-KO part numbers for the Edge design alloy wheel is as follows:

14" AL-KO part 1559417

15" AL-KO part 1559389

16" AL-KO part 1821164

The 4 part kit specified below will contain:

Part A

Box containing security components comprising:

- 1 off High security locking bolt.
- 1 off High security locking bar socket key.
- 1 off Barrel lock.
- 2 off Barrel lock keys.
- Instruction manuals in CD and paper format.
- Security registration card and reference number.

Part B

Wheel specific insert assembly comprising:

- Red coloured wheel insert lozenge assembled with the locking bar and clip.

Part C

- 1 off Wheel spanner.

Part D

- Kit bag.

Note: Two kits will be supplied with twin axle models.

Note: You must register your key within one month of the date of purchase. Should you fail to do this, you will not be able to order a spare key!

- Within your AL-KO kit will find an exclusive security number.
- Please register your card by telephoning 0870 7576788 or 0044 1926 818500.
- You will need to provide a password and provide an answer to a prompting security question.
- Make a note of your password and keep it in a safe place.
- Keep your registration card safe.
- Take your registration card with you when you are travelling with the caravan.
- Always keep your registration separate from the lock.

Safety information

(AL-KO secure)

- Always secure the caravan against rolling away (chock or couple to a towing vehicle).
- Always remove AL-KO Secure before moving the caravan.
- After any attempt of theft has been made on a locked AL-KO Secure, the caravan must be inspected at an AL-KO Approved Service Workshop.
- Always keep the key in a safe place.
- Keep the lock set and registration card separate from the key.
- The lock parts and key do not have a registration number, therefore keep the registration card in a safe place.
- Caravans with twin axles have two locks, keep each lock set in a separate place.
- The sets are not interchangeable!

Operating instructions

- Please read the AL-KO operating instructions supplied with your caravan and act in accordance with them.
- Follow all safety instructions as well as the warning information.
- It is recommended for ease of fit that a side lift jack be used.
- Keep the operating instructions

The AL-KO side lift jack

- See section 5.14 page 50 for details.

Water	60
Water system-introduction.....	60
On Arrival at the campsite / Priming the system	61
Water system - with water tank	61
On Arrival at the campsite / Priming the system	64
To use the caravan with the internal water tank	64
To use the caravan with a mains water connection	64
Plumbing Connections.....	64
Water Pump	65
Ultraflow water intake housing	66
Whale Water In Socket and Watermaster® exterior water pump with Easi-Push Plug.....	67
Water Level Sensor	68
Sanitising	68
Water faults	69
Gas	72
Gas Supply Manifold	74
Types of LPG and LPG Cylinders	74
Gas safety advice	74
Cylinder compartment	75
Gas Hoses	75
Regulators	76
Changing a Gas Cylinder	78
Flue installations	78
Gas faults.....	79
Electrical	80
General Information	80
On arrival at the campsite	80
On departure from the campsite	81
Overseas connection	81
230V mains electrical equipment power consumption	81
BCA battery box	84
Floor mounted battery box	84
Battery installation	85
Battery	85
Solar Energy System	86
Generator usage	87
Habitation relay	87
Exterior 230V socket	87
USB Socket Provision	89

7.1 Water

Water system - Introduction

All fittings, including the holding tank where fitted, water pipes, taps and connections are of food quality material (to BS6920) and therefore, should not affect the quality of the water used.

It is recommended however, that the system is flushed through twice before it is used for the first time, and always cleaned/ flushed after it has stood unused for a period of time (eg over the winter period).

Note: When filling the fresh water system remember to check that the water source is suitable for use as drinking water and, if you are using a hose pipe or water carrier, that it is also made from nontoxic materials (preferably food quality material).

All Swift Group caravan water systems have been designed around a pump fitted within the caravan. This pump draws water from an external source, to provide water pressure within the caravan, whenever it is switched on and water is available.

Note: Before winter storage the water system must be completely drained (see winterisation / storage in the maintenance section).

Note: Clean the water system at the start and end of the season with sterilising fluid (see sanitising section).

CAUTION: Allowing water to freeze in the system may result in damage to the pump and plumbing system.

WARNING: Do not use automotive antifreeze to winterize potable water systems. These solutions are highly toxic and may cause serious injury or death if ingested.

The schematic below shows the basic configuration of the water system with inboard pump and no internal water tank as applicable to **Sprite, Challenger, Challenger X, Eccles & Eccles X** and the second diagram applicable to **Basecamp**.

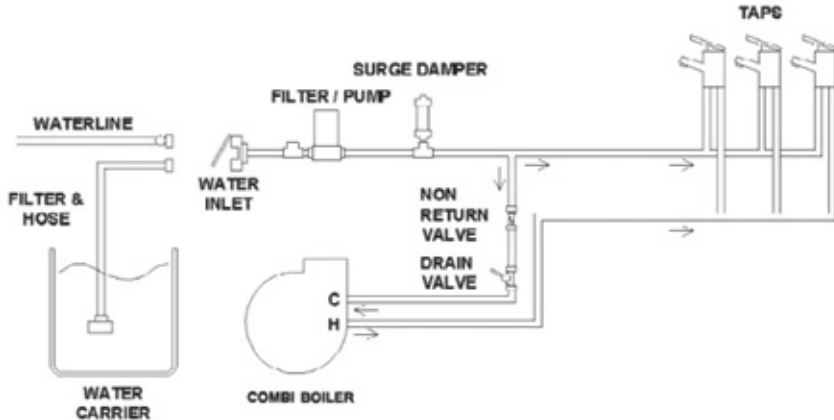

Sprite, Challenger, Challenger X, Eccles & Eccles X

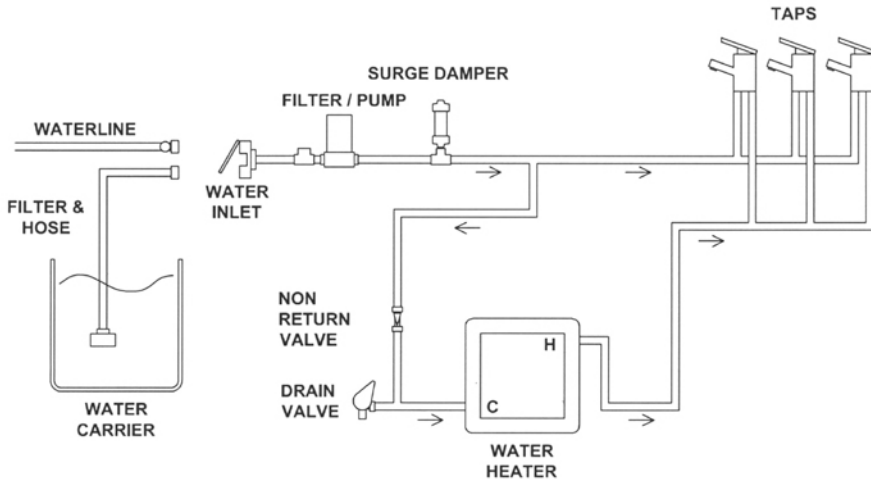

Basecamp

When power is supplied to the pump, it will draw water from the external container through the water inlet mounted on the side of the caravan, and pump it to the caravan taps, shower and water heater.

The pump is fitted with its own pressure switch, and the pump will continue to pump water, until the pressure of water on the output of the pump reaches a pre-set level. For this pressure to be achieved, the taps must be closed.

When the taps are opened, water will leave the tap via the spout, and the pressure in the pipes between the pump and the taps will reduce. Because of this reduction in pressure, the pressure switch on the pump will switch back on and the pump will again run to pump more water.

Close to the pump, the water under pressure is split into two paths:

1. Through blue water pipes routed directly to the cold connection of each tap.
2. To the water heater.

Water from the pump enters the bottom of the water heater. Once the water fills the water heater (typically 10 litres), water then leaves the water heater via a connection at the top of

that water heater. This water, which is still under pressure, then routes to the hot connection of each tap via red pipes.

Tank types – Overview

No Internal Water Tank

A caravan water system with no internal water tank functions in the following way:

The inboard pump draws water into the caravan, via the inlet on the offside of the caravan. This is directed to the water heater, taps and shower. An umbilical hose, with baffle, is supplied with the caravan to connect between the inlet and an aquaroll or similar external container.

On Arrival at the campsite / Priming the system

- Ensure that the external water container is full. (See Ultraflow and Whale water inlets on page 66).
- Close all of the taps (kitchen sink, bathroom, shower) except one, which should be open in the hot position.
- Ensure that the water heater drain valve is closed (move the Yellow handle on the floor near the water heater to a horizontal position).
- Switch the pump on using the button on the

WATER SYSTEM

control panel. Water will flow through the open tap after a short time. This tap can then be moved to the cold position and again after a short time water will flow.

- Repeat the procedure at each tap, including the external shower point (model specific)
- When using a mains water connection the pump will still need to be switched on to supply water to the water heater, taps and shower.
- If a mains water connection is used, please ensure this is a Truma Waterline connection, which has a built in pressure reducing valve.
- To drain / winterise the system please see separate details later in this handbook.

Water system- with water tank

The following arrangement is used for a caravan with internal water tank as applicable to Elegance and Elegance Grande.

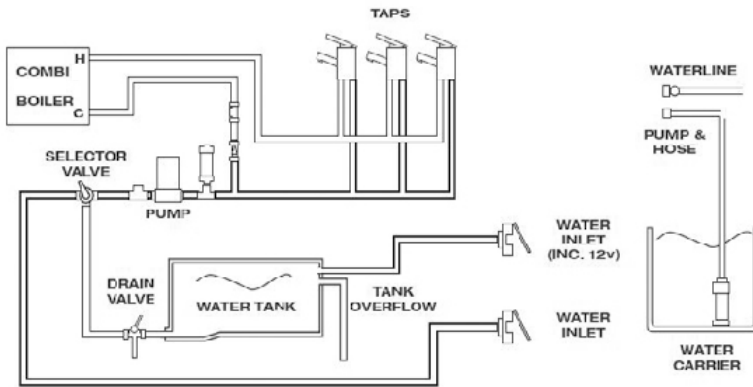
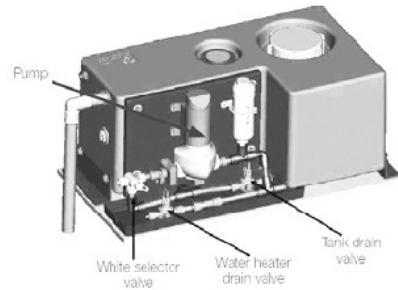

Elegance and Elegance Grande

The control panel above the entrance door is used to control water pumps, and where applicable read water level displays.

- Two water inlets are fitted on the outside of the caravan, on the offside. The upper inlet is used to fill the internal water tank, and the lower inlet is used to bypass the tank. The upper inlet has an electrical connection to power the external water pump. The lower inlet does not provide power for the external pump, water is drawn in by the internal pump only.

- An external pump is supplied with the caravan, this can be used with the lower inlet when the on-board pump is being used to draw water from an external source.
- The same external pump can be used with the upper inlet, this will transfer water from the external source to the internal tank.

- A white selector valve located close to the pump is used to select the water supply from the external source or the internal tank (see below). Please see the label on the bed flap rear, close to the tank for valve operation. The label is also shown below.

The inboard pump draws water from whichever water source is in use.



When power is supplied to the pump, it will draw water from a selected source, and pump it to the caravan taps, shower and water heater. The pump is fitted with its own pressure switch, and the pump will continue to pump water, until the pressure of water on the output of the pump reaches a pre-set level. For this pressure to be achieved, the taps must be closed.

When the taps are opened, water will leave the tap via the spout, and the pressure in the pipes between the pump and the taps will reduce. Because of this reduction in pressure, the pressure switch on the pump will switch back on and the pump will again run to pump more water.

Close to the pump, the water under pressure is split into two paths:

1. Through blue water pipes routed directly to the cold connection of each tap.
2. To the water heater. Water from the pump enters the bottom of the water heater. Once the water fills the water heater (typically 10 litres), water then leaves the water heater via a connection at the top of that water heater. This water, which is still under pressure, then routes to the hot connection of each tap via red pipes.

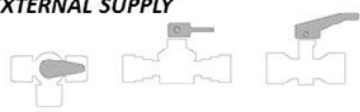
Note: The MRO is calculated with the fresh water tank empty. If you travel with water in the fresh water tank, the payload will be reduced accordingly

<p>INTERNAL TANK SUPPLY</p>  <p>EXTERNAL SUPPLY</p>  <p>DRAIN SYSTEM</p>  <p><i>When using EXTERNAL SUPPLY ensure external pump is connected to lower outer socket. Upper socket is used only to fill internal tank</i></p>	<p>WINTERISATION / STORAGE</p> <ol style="list-style-type: none"> 1) <i>With external pump connected to upper external socket, lift the external pump out of the water container and allow the pump to run briefly.</i> 2) <i>Disconnect the external pump and set the valves to drain the internal tank and water heater, as shown opposite.</i> 3) <i>Open the kitchen tap, vanity tap, shower mixer and shower head to the fully open, mixed hot and cold position, and allow system to drain. Run the internal pump briefly.</i> 4) <i>Disconnect input and output connections to the internal pump and allow water to drain from connections (including filter body). Remove filter until further use.</i> 5) <i>Again run the internal pump for short time to expel any water from the pump body.</i> 6) <i>Unscrew shower head, or shower head and hose, and shake dry.</i> 7) <i>It is advised to leave the pump, and shower head and hose, disconnected until further use.</i> <p><i>Please also check handbook and/or appliance manufacturers instructions for further winterisation advice</i></p>
--	---

ARRIVAL AT THE CAMPSITE / PLUMBING CONNECTIONS

On Arrival at the campsite / Priming the system

The caravan water system can be used with or without the internal water tank. To use the caravan without internal water tank:-

- Ensure that the external water container is full. (See Ultraflow inlet page 66)
- Connect the external pump to the lower connection point on the outside of the caravan, labelled 'direct to taps'.
- Move the white selector valve close to the pump anti-clockwise to select the external source
- Close all the taps except one, which should be open in the hot position
- Ensure that the water heater drain valve and tank drain valve are both in the closed positions (move the yellow handles on the valves fitted near the tank to horizontal positions)
- Switch the pump on using the button on the control panel. Water will flow through the open tap after a short time. This tap can then be moved to the cold position again, after a short time, water will flow.
- Repeat the procedure at each tap, including the external shower point.

To use the caravan with the internal water tank

- Connect the external pump to the upper connection point on the outside of the caravan, labelled 'direct to tank'.
- Ensure that the tank drain valve (which is a yellow handled valve identical in appearance to the water heater drain valve) is in the closed position- with the handle horizontal.
- Rotate the handle of the white selector valve clockwise to select internal tank as the water source.
- Use the control panel menu to switch on the external pump which will run for 7 minutes or shut off when this tank reaches full.
- Water will now be transferred from the external container to the internal water tank. The amount of water within the internal tank can be checked by looking at the water gauge on the control panel.
- Once the control panel shows this level at 1/4 or higher, taps can be used as normal.

- Press the 'water pump' button to switch on the internal pump.

To use the caravan with a mains water connection

- When using a mains water connection the pump will still need to be switched on to supply water to the water heater, taps and shower
- If a mains water connection is used, please ensure this is a Truma Waterline connection, which has a built in pressure reducing valve.
- The Waterline connection should be connected to the lower connection point on the outside of the caravan, labelled as 'direct to taps'.

Plumbing Connections

In most cases, speed fittings are used, which allow easy and quick connection of water pipes.

To connect a pipe to a fitting, simply push the pipe into the connector. To remove the pipe, push the collar of the fitting inwards, and then withdraw the pipe.



To connect a pipe, simply push the pipe into the connector.



To remove a pipe, push the collar inwards, and then remove the pipe.

As a note, when refitting the pipe, ensure the end of the pipe is round (not oval) and the cut is square. If not, it could lead to water leaks.

Water Pump

Water pump pressure switch

The purpose of a pressure switch is to monitor the pressure on the outlet side of the pump. When a tap is closed, and the pump continues to run, there is an increase of pressure in the system, and when that pressure reaches a pre-set limit, the pressure switch will turn the pump off.

Water pump pressure switch adjustment

Pressure Switch Adjustment, Truma/Flo-Jet pump. (Normally Grey upper section with White lower section/valve housing)

- All of the Truma/Flo-Jet pumps used by Swift are pre-set at 25psi - 31psi.
- To further adjust the pressure switch setting, a cover cap must first be removed from the end of the pump to reveal a pressure adjusting screw, as shown in the photos. A maximum of 1/4 turn clockwise or anti-clockwise, from the factory setting, is advised. Turning the screw clockwise 1/4 turn will increase the pressure switch cut-out pressure, turning the screw anti-clockwise will reduce the pressure setting.
- Please note a second screw mounted below the cover cap is set in position with threadlock, this should not be disturbed.

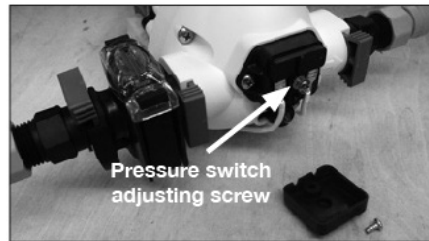
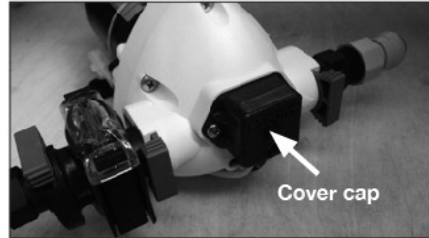

Troubleshooting

Pump will not start, when the tap is opened:

- Check fuse(s).
- Check power source(s), and ensure there is sufficient voltage to run the pump.
- Ensure 'pump' LED is illuminated.
- Using a multi-meter, ensure there is power at the pump. If not, refer to your dealer as there maybe damaged cabling or a fault with the fusebox.
- Is the pump hot? If so, allow to cool before retrying.
- Has the vehicle been stored over winter? Was it correctly winterised? If no, the pump may have frozen, causing permanent damage.
- The pressure switch may need adjusting. See adjustment instructions above on how to do this.

Pump runs, but will not pressurise system (i.e. no or little water being discharged from taps)

- Not Pulsing:

- Ensure water in source is present (on-board tank or aqua roll).
- Check in-line pump filter is free from debris and correctly fitted.
- Ensure water system has been primed correctly, (see page 61) and there are no air-locks present.

ULTRAFLOW WATER INTAKE

- Ensure there are no restrictions in the plumbing.
- Using a multi-meter, ensure there is power at the pump. If not, refer to your dealer as there may be damaged cabling or a fault with the fusebox.
- Ensure the inlet side of the pump (including Truma inlet and in-line filter) are watertight and not allowing air into the system.
- Check (using a multimeter) that the voltage at the pump is between 10v-14.5v.

Pump continues to run (for more than 5 seconds) after taps are closed or pump turns on for no reason:

- Check for leaks on the high pressure side of the pump.
- Ensure water system has been primed correctly, (see page 61) and there are no airlocks present.
- Ensure the pump is securely mounted.
- Ensure the piping on the high pressure side of the pump is in good condition (not blowing or deforming).
- The pressure switch may need adjusting. (See page 65) for information on how to do this.

Noisy or rough operation

- Check for leaks on the high pressure and low pressure side of the pump.
- Ensure that all pipes (especially those within 150mm of the pump) are not touching any furniture.
- Ensure the pump is securely mounted.

Pump rapidly cycles (switches on or off) or water pulses from taps, including temperature pulsing:

- Check for leaks on the high pressure and low pressure side of the pump.
- Ensure there are no restrictions in the plumbing
- The pressure switch may need adjusting. See Section (page 65) for information on how to do this.

Ultraflow water intake housing

Operating instructions

Raise the lid, clean both the water socket and the plug of the Intake Assembly.

Plug the intake connector into the socket.

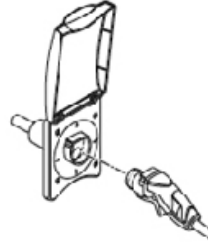

Place the assembly into the water container, ensuring that it is fully submerged before operating the system. The dust cover is to stop contaminants falling into the water container.

When water is first introduced, or the water supply in the internal tank, or aquaroll, runs out, air will be present in the pipework. It is important that every tap is run to remove any air in the system before, for instance, the shower is used. Air left in pipework local to a tap can act as an accumulator and affect the ratio of hot and cold water flowing from other taps or shower mixers in the system.

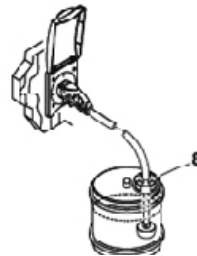

If the pump fails to deliver water the most likely cause will be air in the system. Switch off the pump and shake the pump assembly in the external water container. Then switch on again.

To remove the Intake Assembly from the Water Intake Housing. To remove, pull the lower trigger and pull out the hose plug.

CAUTION: Do not remove by pulling the hose. Please ensure that the lid is properly closed before driving!

Routine maintenance

Ensure that the O-ring seal on the hose plug and the socket are free from dirt. To aid fitting of the plug assembly smear the O-ring with vegetable oil.

Whale Water In Socket and Watermaster® exterior water pump with Easi-Push Plug (when fitted)

To use the water inlet:

1. Fill an external water container, and position the container near the Whale water inlet on the side of the caravan.
2. Slide the lid upwards, by gripping the sides of the lid, as shown on the image below:
3. Place the hose and filter supplied with the caravan, into a full water container

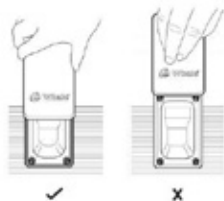

4. Insert plug into water inlet and slide lid down to lock plug in place as shown in the image below:
5. Adjust dust cover over opening in water container as shown in image below. Please note dust cover should not be secured to water container, as air must be allowed to enter the container to replace the water being pumped out.

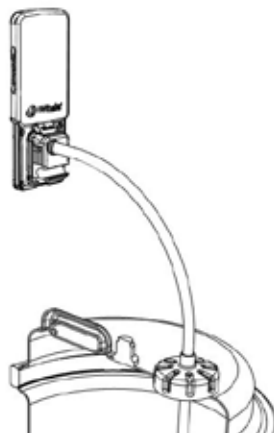

Slide lid up to unlock and remove plug. When removing the plug, simply pull the plug clear of the socket using the hand grip.

Please note: It is recommended that you change your Whale water filter every 3000 litres or after approximately 30 days of use as smells and debris will build up in the filter and effect the pump's performance. No other maintenance is required.

WARNING: This filter cartridge should not be used in water supplies of an unknown bacteriological quality. This is not a bacterial filter.

Non-Toxic antifreeze for potable water may be used with Truma pumps. Follow manufacturers recommendations.

WATER LEVEL SENSOR / WATER SYSTEM SANITISING

Water Level Sensor

(where fitted)

The level sensor, fitted to Swift Group caravans are pre-fitted to water tanks, and link to the fuse box, via a pre-fitted wiring harness. The sensors, which consist of a number of stainless steel rods or probes, at different lengths, are immersed in the fresh water, and use the conductivity of water, between the probes, to provide a reading at the control panel.

Normally, even if the rods are dirty, and providing the rods have not bridged by a foreign object, a circuit will still be made and a water level displayed

The first step, in case of fault diagnosis, is to clean the sensor rods. False water level reading at the control panel can be caused by calcium build up or foreign objects within the tank bridging the probes.

Sensor Cleaning Instructions

Cleaning recommendations for lime scale build up:

1. Remove sensor from tank.
2. Check probes for build up or contamination.
3. Use clean soapy water.
4. Place scourer (a domestic plastic mesh scourer is recommended) in water and dampen.
5. Apply scourer to sensor probe with limited pressure.
6. Rub sensor probe removing contamination.
7. Swill sensor with fresh clean water.
8. Replace probe into tank.

Sanitising

Guidance on cleaning portable water tanks and the water system in touring caravans.

The water systems, and in particular water tanks, in caravans are susceptible to contamination by bacteria if care is not taken with their use and cleaning. The symptoms caused by bacterial contamination are not purely limited to gastro-intestinal diseases, but may also manifest themselves as ear, nose, throat, eye or skin infections. It is therefore important that you carry out the following procedure prior to using the caravan each time, even if you boil or filter all water you use for drinking.

Separate Water Containers

1. All water remaining in the container should be disposed of so that the container is empty.
2. The outside of the container should be thoroughly cleansed and washed down to remove any dirt, dust or other contaminant. Water at a suitably hot temperature containing an appropriate detergent is recommended for this purpose.
3. Water should be put in the container, swirled around, and then emptied out.
4. The container should then be totally filled with water containing an appropriate sterilant solution and allowed to stand for the recommended contact time.
5. The solution should be emptied from the container.
6. The opening of the container should be cleaned thoroughly with an appropriate prepared wipe impregnated with a sterilant.
7. The container should be inverted whilst stored overnight (if possible).
8. The container must be filled with mains water only and mains water only should be used for the above cleaning procedure.
9. On no account should garden hoses be used to fill water tanks.

On board water Systems:

1. Drain down the system (open all taps to allow air in, enabling the system to drain quickly).
2. Remove any aftermarket water filters fitted, and replace with a short length of hose or empty filter cartridge (this will ensure the filter is not affected by the disinfectant/sterilant solution).
3. Fill the system, including the water tank if fitted, by using the pump with a disinfectant/sterilant solution (check that the solution at full strength appears at all taps/showers). Allow to stand for the recommended period of time.
4. Drain the system completely.
5. Thoroughly clean the outside of all taps/connectors with a cloth soaked in the disinfectant/sterilant.

6. Flush the system through with clean drinking water until no traces of disinfectant/sterilant can be detected at any tap.
7. Replace the filter.

Suitable sterilising chemicals are available from your caravan dealer, accessory shop, chemist or home-brew shops. It is not, however, recommended to use bleach or sodium metabisulphite.

CAUTION: To avoid damaging the water system and water heater do not use products that contain aggressive agents, chlorine, bleach or sodium metabisulphite for sterilising the water system.

CAUTION: Never use the water heating system when disinfectant /sterilising fluid is present. Doing so may damage the system.

Fault	Cause	Remedy
Water not flowing from any tap when operated but pump runs	Freshwater tank empty	Check
	Pump wired in reverse	Check wiring, refer to pump manufacturer's instructions
	Pipe inlet or outlet pipe disconnected	Check connections
	Pump pipes restricted by kinking	Check pipes run
	Blockage in pump inlet or outlet pipe	Check, starting inside freshwater tank
Pump does not run	Blocked in-line filter of pump filter	Dismantle and clean
	Air leak in suction line to pump	Check for bubbles.
	Pump or tap incorrectly wired	Refer to pump/tap manufacturer's instructions
	Pump fuse blown	Check wiring connection and then replace with fuse of correct rating
	Battery disconnected	Check connections
	Pump seized or overheated	Refer to pump manufacturers servicing instructions

WATER FAULTS

Fault	Cause	Remedy
	<p>Pressure pump sensing switch may have failed</p> <p>Contacts may be faulty</p> <p>Wiring connections may be faulty</p>	<p>Refer to pump manufacturers servicing instructions</p> <p>Check contacts in plug and socket are clean and making contact</p> <p>Check wiring connections</p>
Water flows from cold tap but not from hot	<p>Feed pipe to water heater incorrectly connected to the heater outlet</p> <p>Blockage in hot pipeline</p> <p>Heater inlet or outlet pipes kinked preventing flow</p> <p>Hot tap not connected</p> <p>Hot tap failed or blocked</p> <p>Heater non-return valve jammed</p>	<p>Refer to installation instructions</p> <p>Disconnect pipes and inspect.</p> <p>Check and re-route if necessary.</p> <p>Check pipe and connect where required.</p> <p>Disconnect and inspect.</p> <p>Refer to dealer</p>
Water flows from hot tap but has reduced flow from cold	<p>Cold water pipe kinked preventing flow</p> <p>Blockage in cold pipe line</p> <p>Cold tap not connected</p> <p>Cold tap failed or blocked</p>	<p>Check and re-route if necessary</p> <p>Disconnect pipes after 1st connector and check up to tap</p> <p>Refer to installation instructions</p> <p>Disconnect and inspect</p>
Reduced flow from both hot and cold taps	<p>Battery condition low causing pump to run slowly</p> <p>If new taps have been fitted they may be restricting flow</p>	<p>Check battery state of charge, refer to electrical supply note</p> <p>Disconnect and check that they have at least 1/4" (6.3mm) bore</p>

Fault	Cause	Remedy
	Pump needs servicing Partially blocked pump filter or in-line filter, if fitted Pump outlet pipe kinked restricting flow Water leak	Refer to pump servicing instructions Dismantle and clean if necessary Check and re-route if necessary Check all water connections
Reduced flow from either tap	Pipe kinking restricting flow	Check and re-route if necessary
If pump motor runs steadily and will not stop	Battery voltage may be too low (below 10.5 volts) Pressure Switch setting problem	Check that there is water in the container Adjust switch and/ or re-charge battery Check all connections in pipework. Adjust settings.

GAS SCHEMATIC

7.2 Gas

All Except Basecamp Gas Schematic

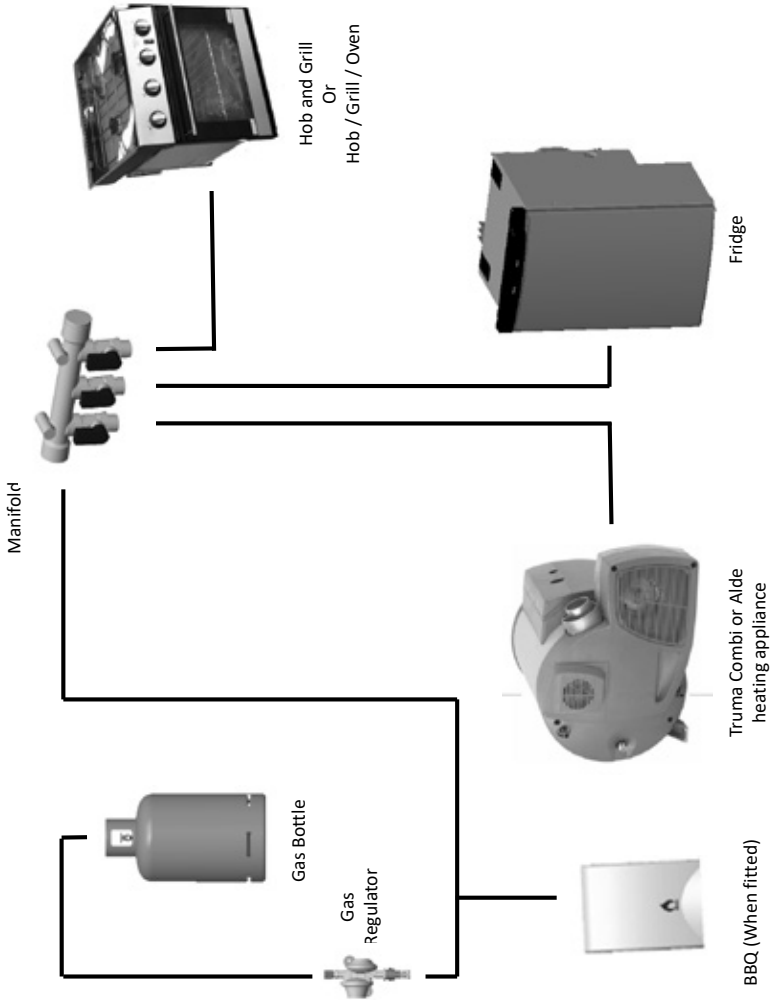

Note: Depending on the caravan model, the gas isolation tap for the water heater may be located close to the appliance. The exact appearance of components may vary

Basecamp Gas Schematic

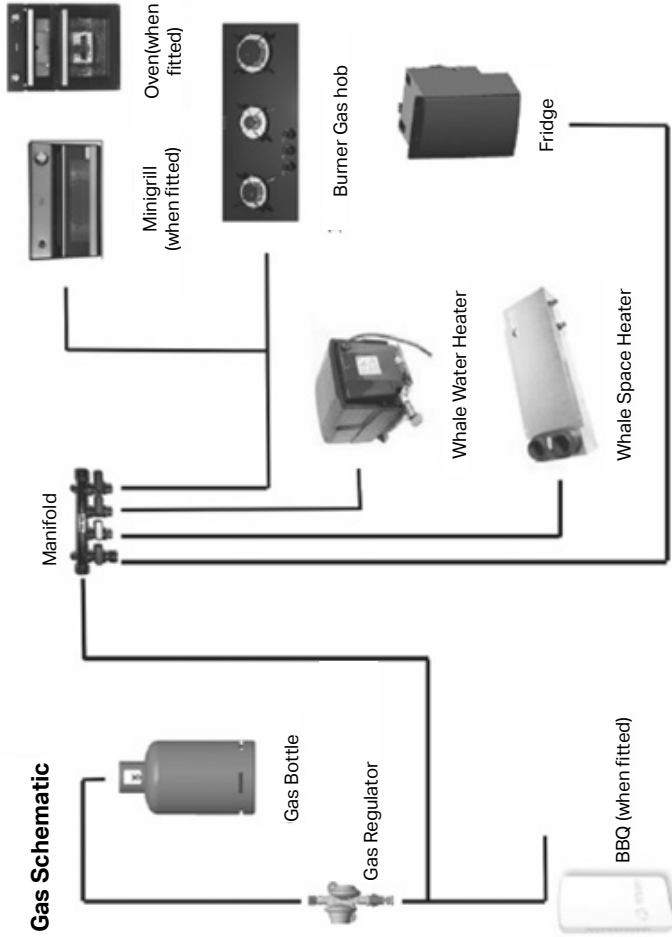

Note: The exact appearance of components may vary

GAS SUPPLY MANIFOLD / TYPES OF CYLINDERS / GAS SAFETY ADVICE

⚠ WARNING: Never allow modification or repair of LPG systems and appliances except by qualified persons.

Gas Supply Manifold

All gas equipment (except barbecue and some water heaters) is supplied through a central Gas Manifold System which has individual isolation taps for each appliance (Fig A), as follows:



WHITE - Alde or Truma Boiler or Whale space heater (Model specific)

BLUE - Fridge

GREEN - Oven

RED - Whale water heater

ⓘ Note: The external barbeque point, when fitted, is fed from the main feed through a built in integrated isolation valve. See schematic layout for details (page 72).

ⓘ Note: In some installations the water heater is fitted with a separate isolation valve.

Types of LPG and LPG Cylinders

Bottled Liquefied Petroleum Gas (LPG) is the most convenient portable source of fuel for your caravan. There are two types available:

Propane

Propane is supplied in red, or partly red bottles which have a female left hand threaded connector.

Scandinavian countries use the same connector.

Germany and Austria supply propane with a male connection.

Propane will work at temperatures as low as -40°C and is therefore suitable for all winter caravanning.

ⓘ Note: We recommend the use of 6kg Calor propane bottles.

Butane

Butane is supplied in the U.K. in green or blue cylinder.

All these have a male left hand thread

EXCEPT for Camping Gaz which has a special female right hand thread and Calor 7kg and 15kg and aluminium cylinders which have a special clip-on connection.

Continental cylinders usually have a male left hand thread similar to but not identical with U.K. butane.

Butane is only suitable for use at temperatures down to 2°C and will not work below that.

Gas safety advice

⚠ WARNING: If you smell gas or suspect a leak or in the event of a fire and if it is safe to do so, isolate the gas appliances and turn off the gas bottles at the regulator. Evacuate the caravan and ventilate. Seek professional advice as to the cause of the leak

- LPG is not poisonous.
- Bi-products are harmless.
- There is danger if all air and oxygen were excluded.
- (Ventilation holes must be kept clear at all times).
- LPG has been given a smell by the manufacturers in order to identify leaks.

Precautions

- Never look for a leak with a flame. Always use a soap solution or its equivalent when testing connections. Do not operate any electrical apparatus whatsoever, especially light switches. If the leak is not obvious, the caravan should be evacuated and qualified personnel consulted.
- Avoid naked lights when connecting or changing a cylinder.
- Check the flexible hose frequently.
- The gas is heavier than air and therefore sinks to the lowest point.

- Keep bottle gas containers outside (and protected against frost). If they must be kept inside make sure they are well away from heat.
- Only use gas cylinders that are located within their dedicated position within the front gas bottle housing, never extend the high pressure hose - hose lengths must not exceed 400mm.
- Regularly check flexible gas hose, joints and connections for tightness.
- Finally make sure that each gas appliance is working efficiently to the recommendations of the appliance manufacturers.
- The LPG system should be inspected annually by a competent person.
- We do not recommend the use of an inline LPG BBQ when other LPG appliances are in use.

⚠️ WARNING: Do not use appliances with a different working pressure to 30mbar

⚠️ WARNING: Maintain adequate spacing of combustible materials from sources of heat.

⚠️ WARNING: Do not use independent portable gas appliances inside the vehicle. Cookers shall not be used as heaters

⚠️ WARNING: A BBQ point inlet valve, if fitted, must only be used for the connection of portable LPG appliances

⚠️ WARNING: Always read individual appliance instructions

⚠️ WARNING: If in doubt ask for advice from a competent person

Awning Spaces LPG Appliance Exhaust

There is no danger of pollution of an enclosed awning space by the LPG exhaust from a refrigerator venting into it, as awning spaces are generally well ventilated.

Space heaters may produce sufficient exhaust to pollute the awning space, if it is totally enclosed, from a general comfort, smell and hygiene point of view. In the extreme case there could be a build-up of carbon dioxide to a dangerous level.

Caravan owners are advised to allow some fresh air circulation in the awning space when such appliances are in use.

Cylinder compartment

All cylinder compartments have two universal plastic mouldings fitted to the floor of the compartment that are designed to fit both steel and BP Gas Light cylinders and two universal support cradles with straps for retaining the bodies of the cylinders at mid to high level and two universal support cradles with straps for retaining the bodies of the cylinders at mid to high level.

⚠️ WARNING: Ensure that the hose assembly is not under stress when connected to the cylinder.

Gas Hoses

A high pressure hose must be used with the regulator to connect to the gas bottle.

LPG cylinders i.e. Propane, Butane and Camping Gaz cylinders all have varying cylinder adaptor connections. It is important to check you have the correct hose and adaptor to suit your gas cylinders. Push on hoses are no longer permitted under the new regulations. The high-pressure hoses have threaded connections and must be securely attached to the regulator and to the gas cylinder.

The pressure regulator relies upon a sealing washer(s) to maintain a gas tight joint, and it is essential to check that the washer is present, sound and correctly positioned prior to making the connection. The gas cylinder connection relies on a metal seating or bull nose connection to obtain a gas tight joint, therefore it is essential that the mating surfaces are clean and undamaged. In no case should a damaged valve or connection be used.

Ensure that there is a constant rise in the flexible gas hose between the gas cylinder outlet and the regulator elbow.

⚠️ WARNING: Inspect flexible gas hose(s) regularly for deterioration and renew as necessary with the approved type, in any case no later than 5 years after the date of manufacture marked on the hose

REGULATORS

⚠ WARNING: Ensure hoses do not become entangled in locker door mechanism.

Regulators

Your caravan is supplied with a wall mounted gas regulator plumbed inside the gas cylinder compartment. The regulator and all appliances work at a harmonised 30mb pressure, which work with Butane and Propane gas.



Pressure regulation system in this vehicle has a fixed working pressure of 30 mbar with a flow rate of 1.5 kg/h and complies with the requirements of EN 12864 annex D.

ⓘ Note: Regulator valves and cylinder valves should always be in the 'OFF' position when towing unless en-route heating is fitted and in use.

⚠ WARNING: When leaving the caravan for any period of time or storage always turn off the gas at the gas cylinder

DuoControl (Model Specific)



The DuoControl combines the gas pressure regulator and the changeover valve in one unit for operation as a two-cylinder system. When the operating cylinder is empty, DuoControl automatically changes over to the reserve cylinder.

- Combines a gas pressure regulator and a changeover valve in one unit
- Automatically switches over to the reserve cylinder
- Complies with EN 13786

The Truma MonoControl or DuoControl Crash Sensor Regulator approved for en-route heating (model specific)

Approved for en-route heating if your caravan has a factory fitted habitation en-route LPG heating system that can be used whilst travelling. Fig 1 shows the two safety valve features that are part of the system, these are there for your safety whilst using the system when travelling. When in use ensure all other gas appliances are separately isolated.

⚠ WARNING: For safe operation of the en-route heating both the crash sensor regulator and rupture protected hose must be in use.

⚠ WARNING: When replacing the high pressure hose only purchase a genuine Truma rupture protected hoses

Use of safety devices:

1. Open cylinder valve
2. Firmly press the hose rupture protection (green button) on the high pressure hose for about 5 seconds (fig 1 item 1)
3. If the Yellow reset button (fig 2, item 7) is not pressed ("not ready for operation" position), reset the crash sensor. To reset, press the Yellow reset button (fig 2, item 7) firmly turn it slightly clock-wise, hold it for 5 seconds and ensure that it stays in the "ready for operation" position (figure 2). If the re-set is not successful, use the Torx (T20) screw aid (fig 3, item 12) to support the clockwise rotation.

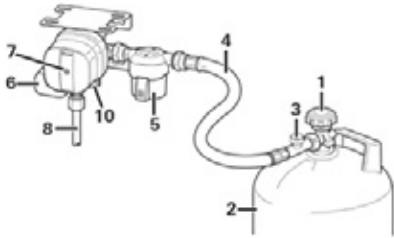

Fig. 1



Fig. 2

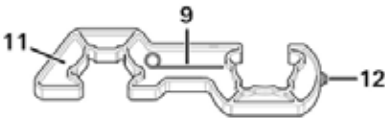

Fig. 3

⚠️WARNING: Isolate cylinders when re-fuelling

⚠️WARNING: Unless en-route heating is in use the LPG cylinder valve should be closed when driving

📌Note: The LPG regulator should be replaced no more than 10 years after their date of manufacture

Enroute heating

If your caravan is equipped with an LPG en-route heating system, the system is installed with additional safety features.

⚠️WARNING: When re-fueling your caravan, switch off the heater and close the cylinder valve.

Safety features

- MonoControl CS regulator incorporating a crash sensor which stops the gas flow in the event of the caravan being involved in a traffic collision.

- Gas flow monitor
- Hose rupture protection is installed.

The full system is Homologated in compliance with UN ECE regulation 122

📌Note: The regulator should be replaced no more than ten years after manufacture.

⚠️WARNING: To ensure the safe working of the en-route heating, any replacement high pressure hoses must be of the same type as the original fitted. They must have the safety valve to ensure that the gas does not leak out in the event of damage to the pipework in the event of a collision.

⚠️WARNING: When travelling using the en-route system all other LPG appliance shut off valves must be in the closed position including the fridge, cooker, water, heater etc.

Note: It is dangerous and illegal to operate other LPG appliances whilst travelling

⚠️WARNING: Never allow modifications or repairs of electrical or LPG systems and appliances except by qualified persons.

⚠️WARNING: When leaving the caravan for any period of time or storage always turn off the gas cylinder.

CHANGING A GAS CYLINDER

Changing a Gas Cylinder

Please use the correct size spanner for the gas hose connectors as this will prevent damage to the screw fittings and ensure that the fitting is tightened sufficiently.

- Turn off all gas appliances
- Close the empty gas cylinder's valve.
- Remove the high pressure hose from the gas cylinders.
- Attach the high pressure hose to the full gas cylinder.
- Open the full cylinder's valve.
- Press the hose-break safety device.
- Check the hose connection to the cylinder valve for leaks

Connection

Ensure that the gas regulator hose is correctly connected to the gas cylinder in the gas bottle compartment and that the hose connection is tight.

Gas bottles must be fully located, seated at the base of the bottles and restrained by the strap provided in the dedicated compartment.

⚠ WARNING: If using cylinders other than those recommended, the user must ensure these are adequately supported, ventilation openings must not be obstructed and the cylinders must not cause damage to other fixtures and fittings located in the compartment

Open ended gas hoses must always be protected from dirt and insects.

Before turning on the gas supply at the regulator, ensure that all gas operated equipment in the caravan is turned off.

Flue installations

All flue installations should be inspected once a year throughout their length for corrosion. Flues should be replaced if any sign of perforation is found. Ensure that the replacement is of an approved type and fitted by a qualified and competent person.

Fault	Cause	Remedy
Hob does not light	No gas	Check level of gas in the cylinder Check gas cylinder valve is on Check gas taps are on
	Air in pipe	Purge system Refer to hob manufacturers instructions
Oven does not light	No gas	Check level of gas in the cylinder Check gas cylinder valve is on Check gas taps are on
	Air in pipe	Purge system Refer to oven manufacturers instructions
Alde or Truma boiler will not light.	No gas	Check level of gas in cylinder Check gas cylinder valve is on Check gas taps are on Check exhaust outlet is clear Turn off appliance, wait 2 minutes and try again
	Over gassed	Purge system
	Air in pipe	Refer to boiler manufacturers instructions
Fridge does not light	No gas	Check level of gas in the cylinder Check gas cylinder valve is on Check gas taps are on
	Air in pipe	Purge system Refer to fridge manufacturers instructions

7.3 Electrical

General Information

It is strongly advised that the mains installation is inspected periodically to ensure safe use. The IET (BS7671) wiring regulations recommend that mains installations in touring caravans are re-inspected every 3 years. The National Caravan Council lists the qualifications necessary to perform this inspection, but an NICEIC approved contractor is probably the first choice.

On arrival at the campsite

- Disconnect hitch and 13 pin plug from the towing vehicle.
- Place the 13 pin plug in the holder provided to prevent damage.



- Check the suitability of the supply, is it AC or DC, is the voltage and frequency correct.
- Ensure that there is a proper earth (3 pin socket outlet).
- If in doubt consult site staff.
- Make sure that the supply from the site is switched off.
- Make sure that the charger switch on the PSU is switched off.
- Open the battery box door and insert the connector on the flexible supply cable supplied with the caravan, (see page 84) into the socket on the left hand side of the box.

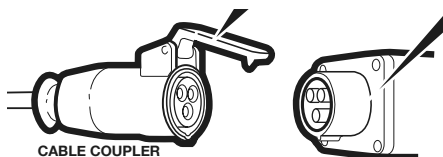

- At the site supply point, connect the other end of the supply cable to this using the socket provided.
- Switch on the main switch at the site supply point.

Note: It is good practice to test the RCD (Residual Current Device) in the PSU before switching on. There is a test button on the RCD to test the lever, put the lever in the up position (on) before testing.

Note: As with the RCD it is good practice to check the Miniature Circuit Breaker (MCB) in the PSU. Switch all to the on position (lever up). If any do not stay up then there is a fault.

On departure from the campsite

- Switch off supply from the site, disconnect the cable at both ends.
- Switch off RCD.

Note: Current consumption in the caravan must not exceed 16 amps or the pitch permitted maximum if this is less than 16 amps

Overseas connection

- Connection to a mains voltage overseas requires particular attention.
- Overseas supplies can be of reverse polarity.
- Reverse polarity results in equipment not necessarily being isolated when turned off, reverse polarity indicator on the PSU will light in the event of reverse polarity.
- The only sure way to make equipment safe is to unplug it.
- It is useful to have a means of checking polarity when overseas.
- If it can be achieved then connect live to live, and neutral to neutral to achieve full electrical protection.

WARNING: Never allow modifications or repair of electrical or LPG systems and appliances except by qualified persons

230V mains electrical equipment power consumption

Note: It is possible that the 230v mains electrical equipment may not all operate simultaneously. A typical UK site mains hook up point provides a maximum output of 10 amps and on some continental sites the available output may be as low as 5 amps. If your loading exceeds the site supply it may trip the site circuit breaker. Please check the available mains supply with your site operator.

Similarly loadings on each circuit breaker within the caravan should be observed. A label positioned close to the MCB's (Miniature Circuit Breakers) will identify which appliances within the caravan are fed from which MCB. Consulting the typical appliance consumption figures table in conjunction with this label, will give an indication of which appliances can, and cannot, (site supply allowing), be operated simultaneously.

WIRING OF CONNECTING CABLES AND CARAVAN MAINS INLET

Wiring of connecting cable and caravan mains inlet

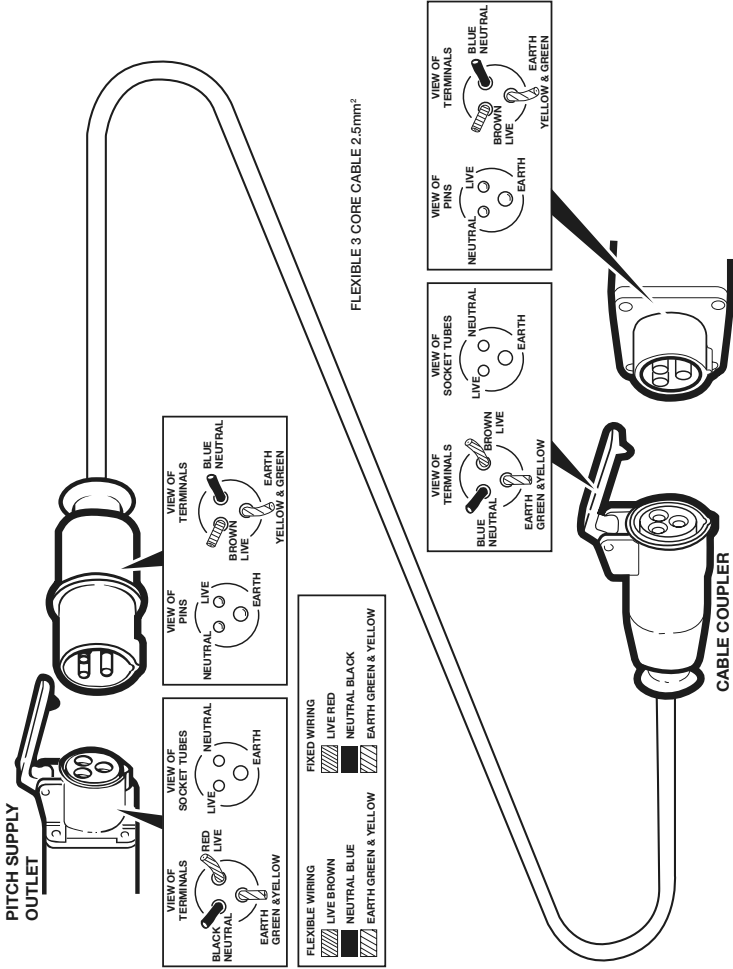

The legal length of the mains inlet cable is 25 ± 2 metres. When in use it must be fully uncoiled and protected from traffic.

TYPICAL APPLIANCE CONSUMPTION FIGURES

Typical appliance consumption figures

Appliance/ Item	230 Volt		12 Volt		LP Gas grams/hour
	Watts	Amperes	Watts	Amperes	
Dometic Refrigerator	190 W	0.8 amp	Only when driving		16 g/h
Turma Combi 4kW Heating System	900/1800 W	3.9/7.8 amp	13W	1.1 amp (avg)	320 g/h
Turma Combi 6kW Heating System	900/1800 W	3.9/7.8 amp	13W	1.1 amp (avg)	480 g/h
Alde Heating System	1050 / 2100 / 3150W	4.6 / 9.1 / 13.7 amp	12W	1.0 amp	245 - 460 g/h
Microwave (Factory fit)	1270W	5.5 amp	Not Applicable	Not Applicable	Not Applicable
Cooker - Hob burners	Not applicable	Not applicable	Not applicable	Not applicable	70 – 161 g/h
Cooker - Electric Hotplate	800W - 850W	3.5 - 3.7 amp	Not applicable	Not applicable	Not applicable
Grill	Not applicable	Not applicable	(cooling fan) 0-14.4W	(cooling fan) 0-1.2 amp	117 g/h
Oven	Not applicable	Not applicable	(cooling fan) 0-14.4W	(cooling fan) 0-1.2 amp	125- 146 g/h
Battery Charger	690W	3.0 amp	Not applicable	Not applicable	Not applicable
Ornivent	Not applicable	Not applicable	2 W- 86 W	0.2 amp - 7.2 amp	Not applicable
12V LED lights (each, depending in size of light)	Not applicable	Not applicable	0.4 W - 6.1 W	0.05 amp - 0.5 amp	Not applicable
Pressure switched pump	Not applicable	Not applicable	48W	4.0 amp	Not applicable

Note: These are approximate figures for guidance only, and are subject to changes in specification. The figures show energy consumption when an item or appliance is operating – i.e. a light is illuminated, or a heating system is providing space heating or water heating. Appliances which feature LCD or illuminated control panels can have a low current consumption when in stand by mode, or have a constant low current draw in the background to run their displays and electronic systems – these figures are typically 0.4 amps or less, for each applicable item. These electronic items can in most cases be switched off individually, or use of the System Shutdown button on the power supply unit isolates all of these items.

BCA BATTERY BOX / FLOOR MOUNTED BATTERY BOX / MAINTENANCE

BCA battery box (All except Basecamp)

The Battery Box is intended to accommodate an auxiliary battery in your caravan. The Battery Box has a CE socket for the 230 V power supply hook-up cable supplied with the caravan and a satellite aerial connection on some models.

When closing the door, the attached cable should be fed through the slot in the door to allow the door to fully close and lock.

⚠WARNING: Use precaution when mounting the battery, as batteries contain acid liquids which can cause severe injuries and damage when handled incorrectly. Refer to the instructions on the battery.

No smoking is allowed in the area of the Battery Box!

Please note that the CE socket has a max of 16 amp

Before placing the battery inside the Battery Box, the battery should be placed in the Soft Tray and rested on the ground or on a suitable platform (e.g. entrance step) adjacent to the Battery Box. Carefully connect the electrical wires (the red cable attaches to the + pole and the black cable to the - pole of the battery).

⚠WARNING: Incorrect connection of the cables will cause a short circuit with potential hazardous consequences.

After mounting the terminals, lift the battery together with the Soft Tray into the middle of the Battery Box compartment. Push the battery to the back of the Battery Box.

The battery is then secured by restraining straps (see fig A).

Fig. A



ⓘ Note: The maximum battery size that can be fitted is 225mm high (including terminals) x 175mm deep x 353mm wide. The depth and width dimensions include the rim around the bottom used for securing the battery.

Floor mounted battery box

(Basecamp)

Your Basecamp caravan is fitted with a floor mounted battery compartment (Batteries not supplied)

Floor mounted compartments are designed to hold the battery securely and to contain any electrolyte (acid) spillage. Under floor compartments are sealed from the habitation compartment and a breather pipe is fitted to ensure any build up of explosive gases (hydrogen) is vented to the outside. If a breather pipe is fitted it is important to ensure that any replacement batteries are also fitted with a breather pipe. The battery should only be positioned in the appropriate compartment, and be properly secured before travelling.

⚠WARNING: Batteries fitted in the floor mounted compartment must be kept upright to prevent the electrolyte spilling out.

Cleaning and maintenance

Use protective clothing and glasses when handling a leaking battery, and avoid direct contact to the skin, eyes and respiratory organ.

Should a battery leakage occur, please act according to the instructions supplied by the manufacturer of the battery. Act with caution as caustic substances are present in the battery.

Always remove the battery and the power cable before carrying out any maintenance of the product.

Before removing the clamps switch off all electrical and gas appliances.

Use a soft cloth or sponge and a non-acid/abrasive detergent when cleaning the battery box or soft tray.

To check if any acid is present in the soft tray or bag, simply press it softly. A strong smell from the soft tray may also indicate spilled acid. Always treat spilled battery acid as hazardous waste. Dispose of spilled battery acid according to the local and national regulations.

Before the camping season or extensive travelling, check the soft tray or bag for faults and replace if necessary.

The cleaning of the battery box and soft tray or bag should only be done after all power sources have been switched off, in order to prevent a hazardous situations.

Battery installation

Under normal circumstances it should not be necessary to remove the battery other than for routine inspection of terminals and 'topping up' if required.

⚠ WARNING: Explosive gases may be present at the battery. Take care to prevent flames and sparks in the vicinity

Your caravan has been fitted with an in-line fuse between the battery terminal and caravan harness. It is recommended that the fuse rating fitted in this location does not exceed 20 amps.

⚠ WARNING: Switch off all electrical and gas appliances and lamps before connecting or disconnecting the battery. Open flames and smoking are prohibited around the battery compartment.

To preserve the life of your leisure battery and charger please observe the following:

Do not leave all 12V appliances powered at the same time as this will drain your leisure battery more rapidly.

If all 12V appliances must be powered together, ensure the battery is 'in-circuit' and that the battery charger is turned on.

For optimum performance use the transformer/charger unit with a leisure battery attached.

Battery

It is recommended that a good quality rechargeable leisure battery is always in circuit when the system is in use.

A deep cycling heavy duty 12V battery should be purchased to provide power for lights and other electrical appliances.

We recommend a proprietary brand leisure battery with a minimum 85Ah capacity (minimum 75Ah on Basecamp) from the NCC verified battery scheme is used.

ⓘ Note: 85 Amp batteries and above should be checked dimensionally before purchasing, to ensure fitment within the battery compartment, as brands vary in size.

It should be remembered that batteries suitable for the electrical demands of a caravan differ in design from those for use with a car, and whilst the system may operate with a car battery it is strongly recommended that only a leisure type battery, maintained in good condition is used. The battery should be kept topped up at all times if required.

⚠ WARNING: Any replacement auxillary battery shall be of the same type and specification as that originally fitted or as specified by Swift.

ⓘ Note: Your caravan is fitted with Swift Command Tracker (by Sargent) which monitors battery voltage. If you plan to disconnect or remove your leisure battery for maintenance or external charging, then please contact the monitoring station before you remove or disconnect the battery.

If a leisure battery is not fitted, please also contact the Tracker monitoring station before removing the mains hook up.

The Swift Command Tracker monitoring station can be contacted on 0345 6027302

Solar Energy System

(when fitted)



This solar panel and regulator will provide additional 12v power whenever sunlight is available to the panel, and this will be directed to the leisure battery whether the control panel is ON or OFF, and regardless of the position of the SYSTEM SHUTDOWN button. If a factory fitted alarm system is present, that alarm will in turn be able to use the leisure battery as a power supply. Conditions allowing, the system keeps the leisure battery 'topped up' during storage, and will provide a daily boost to the leisure battery when camping without a mains 230V supply.

Note: If additional solar panels are fitted and linked to the factory fitted panel, the maximum combined wattage must not exceed 150W.

An 80w panel is capable of supplying up to 4.8 amps, +/- 1.5%.



Unlike typical regulators, the factory fitted solar panel regulator has been specially designed to draw no power from the leisure battery when the solar panel is not generating power. This feature is desirable especially in winter months when a normal regulator can gradually discharge the leisure battery.

Regulator operation

The regulator operates automatically, turning on and off as required to charge and maintain the leisure battery. When the solar panel is exposed to a source of sunlight the regulator starts to operate. When the voltage from the panel reaches a usable level, the Panel Output LED will flash indicating that the battery is being charged (see battery charging below). If insufficient power is being generated by the solar panel the regulator will turn off. The regulator checks the solar panel output every 30 seconds and turns on and off as required. On overcast days when the solar panel output is minimal the regulator can still deliver a small charge, and in this mode the LED's are not illuminated to conserve power.

Battery charging

If a leisure battery is fitted and requires charging the Charge Status LED will illuminate. Depending on the state of charge of the battery this LED will illuminate red for bulk charge (14.4V output) or green for float charge (13.6V output). It may take a few hours to several days to charge the battery depending on its state of charge. When the battery is fully charged the regulator will turn off to prevent overcharging of the battery. If the mains charger is turned on to charge the leisure battery this can also cause the solar panel regulator to turn off.

Power Supply Unit

The PSU does not need to be switched on (shutdown button in) for the solar panel to charge the battery. During caravan storage the PSU should be shutdown (shutdown button out).

Control Panel

When the solar panel is operating the voltage display on the leisure battery will increase if the loads placed on the battery are sufficiently light.

Maintenance and cleaning

The solar panel will require cleaning periodically in order to maintain the performance of the panel, a caravan, car shampoo or simple soap can be used; no abrasive cleaners should be used.

Generator usage

Caution should be used before connecting a generator to your caravan.

CAUTION: Never start or stop the generator while electrical loads are connected and switched on. Start the engine, let it stabilise, then connect the electrical load. To stop engine, disconnect the electrical load and let engine stabilise before switching off.

Whilst some generators use inverter technology, others use a more basic principle to generate the 230v supply. Preference should be to choose a generator which produces a consistent sinusoidal wave form with accurate voltage control.

The reverse polarity warning light may illuminate when using a generator. This is a normal side effect when using some types of generator. Instead of connecting the neutral and live conductors 110v above earth. This 110v difference causes the neon polarity indicator to illuminate.

In most cases it is safe to continue to use the generator, but please consult the generator handbook for further information.

Habitation relay

Habitation relays are fitted to caravans by manufacturers to comply with the following legislation:

1. The Road Vehicles (Construction and Use) Regulations 1986 Regulation 60 - Radio interference suppression
2. European Community Whole Vehicle Type Approval (ECWVTA) framework directive 2007/46/EC and EU Regulation 661/2009 (General Safety) mandates UNECE Regulation 10 (Vehicles with regard to Electromagnetic compatibility)

A habitation relay must be fitted by manufacturers, safe guarding the consumer. The purpose of the relay is to disable non-homologated appliances / components whilst the vehicle is in transit.

Unintentional electromagnetic energy can be created by non-homologated devices within the habitation compartment, which could cause a malfunction of the caravan's electronic systems/components.

Exterior 230V socket (when fitted)



Truma socket

The recessed electric socket is designed to give you a convenient electrical access point on the outside of the caravan, which is completely protected from the weather, even when in use.

With the caravan stationary and connected to a 220v/240v supply, raise the front cover of the socket and insert the plug of the equipment to be used. Close and latch the cover into place to provide a weatherproof seal.

WHALE SOCKET

Whale Socket (Basecamp only)



This easy access mains out socket includes a UK 3 pin which allows you to hook up electrical appliances with a 13-amp rating such as power tools, lighting, TVs or games consoles. The Easi-Slide lid is designed to be closed completely when in use, weatherproofing the unit against the elements.

Operation:

Open the sliding lid as shown in the image below

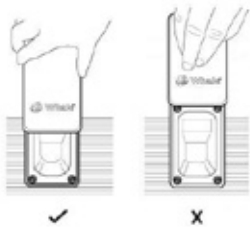

Opening the sliding lid



When the caravan is stationary and connected to a 220V/240v supply, raise the front cover of the socket and insert the plug of the equipment to be used. Close and latch the cover into place to provide a weatherproof seal.

⚠ WARNING: All socket lids must remain closed when not in use. In adverse weather conditions, for example, snow, frost or heavy rain, please note risk of electrocution exists.



USB SOCKET PROVISION

Please remember that the equipment plugged into the socket may or may not be weatherproof. Check the equipment manufacturers instructions.

To disconnect equipment, raise socket cover and remove plug, then close and latch the cover into place to ensure a weatherproof seal.

Before moving the caravan from a pitch ensure that all accessory points are disconnected and latched in the closed position to prevent the ingress of water or other foreign matter from causing damage to the point or any of the caravans services.

Any item plugged into this socket will be supplied by the same 10A breaker (MCB) as the other items plugged into sockets within the caravan. Please take into account the total loading placed on the socket circuit and the site supply before switching equipment on. The socket should be used to power a single appliance with an appropriate power consumption rating.

Note: The socket is NOT suitable for use as a supply to power an adjacent caravan or motorhome or for charging a hybrid or electric vehicle.

USB Socket Provision



In addition to the 230v sockets and 12v sockets present on the binnacle (where fitted) at the front of the caravan, all models have a USB power socket on the front binnacle or mounted on furniture. This can be used with a variety of devices such as mobile phones, media players etc, as a power supply for continued running of the device or charging of the internal battery of that device. The socket

provides a 5v output in line with the usual USB specification and is powered by the leisure battery and/or charger. The connecting lead between socket and device is not provided, as the format of this lead is device specific.

The fitted USB socket is limited to an output of 2.0 amp – for larger devices such as tablets, use the adjacent socket with an appropriate adaptor. Please check the instructions supplied with your device for further details.

Note: The USB socket does not provide a means of transferring or storing data, and so is not intended for use with memory sticks or other data storage devices.

Note: Further USB sockets of the same specification may be fitted elsewhere in the caravan (model specific)

Swift Command power control system introduction	92
Using the system	92
Activating the system	92
Connecting to the Mains 230V supply and Safety checks	93
Operation while driving	93
Control panel operation	94
Control panel 'header' information	96
Temperature readings	96
Water system operation	96
Lighting and dimming operation	97
Solar charge management	97
AC current limiter operation	98
Heating controls	99
Air-conditioning controls.....	101
Radio DAB/FM controls.....	102
Refridgerator controls.....	103
Bluetooth pairing and other controls	104
System warnings	105
System technical information	107
Generator usage	107
Battery charger	108
Leisure Battery	108
12 Volt DC Fuses	110
Electrical faults.....	112
Contact details	114
Remote access and control	115
Swift Command App	115
Swift Command web usage	115
Swift Command Sim coverage and usage information	115
Replacement parts	115
Updates	115
Technical Data	116
Approvals	117

SWIFT COMMAND POWER CONTROL SYSTEM

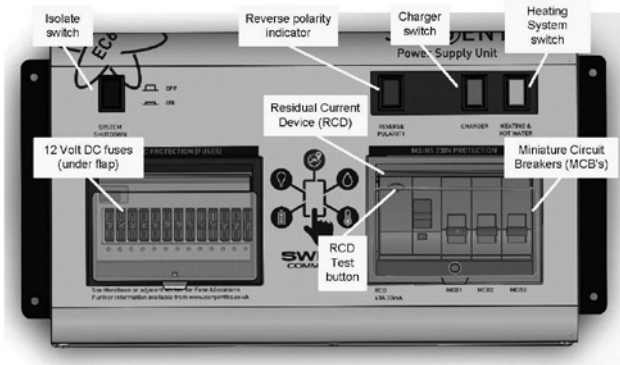

Swift Command Power Control System

8.1 Introduction

This section of the handbook will guide you through the operation of the electrical system. All details are correct at the time of going to press. Please also see the online version which will include any later updates or amendments.

Further technical details are contained in section 3 or in the supporting technical manual available from www.sargentltd.co.uk

For the safe operation of all electrical equipment within your Leisure Vehicle it is important that you read and fully understand these instructions. If you are unsure of any point please contact your dealer / distributor for advice before use.

The system has a number of key components that you will need to be familiar with before attempting to use the system, these are:

- The EC601, EC602 Power Supply Unit (PSU) - a combined mains consumer unit and 12V controller usually located in a storage area (lower bed box, wardrobe or similar).
- The EC800 Control Panel (CP) - a remotely located user control panel used to turn circuits on and off and to display battery, water tank and other system information. This panel uses graphical touchscreen with straightforward controls and reliable data communication to the PSU.

The PX300 Intelligent Battery charger 300W.

- The C44+ Road Light Fuse Box - This small unit is located in the front bed box. The unit houses fuses for the road lighting circuits and supplies from the tow vehicle, and also has connectors for the optional alarm system and Automatic Trailer Control (ATC) unit.

8.2 Using the System

8.2.1 Power Supply Unit - Component Layout (see image above)

The PSU is located in the front offside bed box area. In Basecamp models it is located in the wardrobe.

8.2.2 Activating the System

The system has a shutdown feature that can be used when the vehicle is in storage. This allows the leisure electronics to be turned off when not required to save battery power. When in the off state the alarm and tracking system supplies are still active, all other supplies are turned off.

Before using the system please ensure the system shutdown switch is in the on position (button in) the system is now active.

Note: If you plan to use the Swift Command remote features the system needs to be active.

8.2.3 Connecting to the Mains 230V supply and Safety checks

For your safety it is IMPORTANT that you follow these connections instructions each time your Leisure Vehicle is connected to a mains supply. This section assumes that the system is complete and that a Leisure battery has been installed (see 3.4).

A) Ensure suitability of the Mains Supply.

Your Leisure Vehicle should only be connected to an approved supply that meets the requirements of BS7671 or relevant harmonised standards. In most cases the site warden will hold information regarding suitability of supply. If using a generator you also need to comply with the requirements / instructions supplied with the generator.

Please note that some electronic generators may not be compatible with your leisure system. Further generator operational information is contained in section 3.2

B) Switch the PSU Battery Charger / Power Converter OFF.

Locate the green 'Charger' power switch on the PSU and ensure the switch is in the off position (button out) before connection to the mains supply.

C) Connect the Hook-up Lead.

Firstly connect the supplied hook-up lead (orange cable with blue connectors) to the Leisure Vehicle and then connect to the mains supply.

D) Check Residual Current Device operation

Locate the RCD within the PSU and ensure the RCD is switched on (lever in up position). Press the 'Test' button and confirm that the RCD turns off (lever in down position). Switch the RCD back to the on position (lever in up position). If the test button failed to operate the RCD see section 3.1.

E) Check Miniature Circuit Breakers

Locate the MCB's within the PSU (adjacent to the RCD) and ensure they are all in the on (up) position. If any MCB's fail to 'latch' in the on position see section 3.1.

F) Turn the PSU ON.

Locate the black 'Shutdown' button and ensure it is in the on position (press button in). Locate the green 'Charger' switch on the PSU and turn to the on position (press button in). The charger switch will illuminate when turned on.

G) Check correct Polarity.

Locate the 'Reverse polarity' indicator on the PSU and ensure that the indicator is NOT illuminated. If the indicator is illuminated see section 3.2

H) Check operation of equipment.

It is now safe to operate the 12V and 230V equipment.

8.2.4 Operation while driving

The power control system is designed to shutdown parts of the system while the engine is running. This is to meet Electro Magnetic Compatibility (EMC) regulations and to ensure the safe operation of the caravan. With the engine running the screen will show a warning 'ENGINE RUNNING'.

Please ensure the system shutdown switch on the PSU is in the on (button in) position before driving (see 2.2). This will ensure the electronic system is active and will therefore be able to control the charging process, supply the refrigerator and monitor other system circuits.

Some caravans may also be specified with enroute heating which will also remain operational while the engine is running.

SWIFT COMMAND POWER CONTROL SYSTEM

8.2.5 Control Panel - Component Layout (see image below)

Your control panel will have an appearance as below, but depending on your specification of the vehicle the control panel features will vary. Not all features are present in all vehicles.

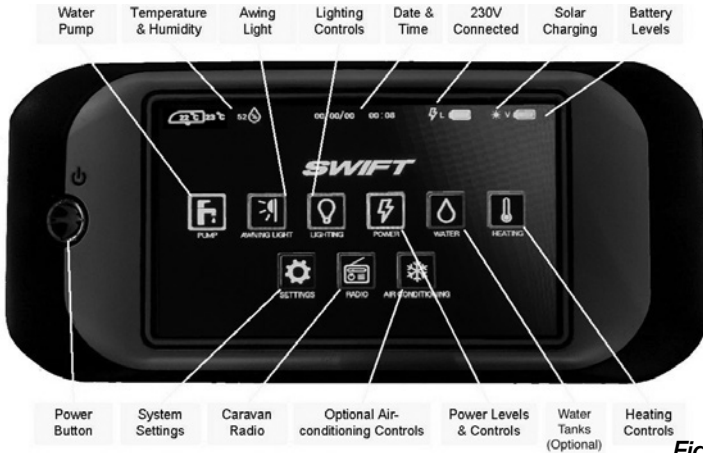

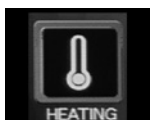





Fig 2

8.2.6 Control Panel - Key Features

	<p>'Swift' Power Button. Press the 'Swift' power button to turn the leisure power on, the panel will beep twice and show the Swift start-up logo. The control panel screen will illuminate when the power is on, but the screen will go to sleep after a pre-determined time. Pressing the power button or touching the screen while the screen is asleep will wake the screen without turning the power on or off. To turn the power off press and hold the power button to turn the power off, the panel will beep once.</p>
	<p>Pump Button. Press the pump button to turn the water pump on. Press the button again to turn the pump off. The button border will illuminate when the pump is on. To view the water tank levels and other controls press the water button.</p>
	<p>Awning Light Button. Press the awning light button to turn the awning light on or off. The border of the button will illuminate when the awning light is on. Note the awning light may also be controlled by the caravan alarm system.</p>
	<p>Lighting Button. Press the lighting button to show the lighting control screen. Here you can turn on / off or adjust the dimmable lighting levels. Press the home button to return to the main screen.</p>

	<p>Power Button. Press the power button to show the power information and control screen. Here you can view battery levels, view charger and solar current and press the more button (right arrow) to view 230V current. Press the home button to return to the main screen.</p>
	<p>Water Button. Press the water button to show the water tank information and control screen. Here you can view tank levels and control related features. Press the home button to return to the main screen.</p>
	<p>Heating Button. Press the heating button to show the heating control screen. Here you can control the heating system, select energy and temperature and by pressing the more button (right arrow) you can set related timers. Press the home button to return to the main screen.</p>
	<p>Air-Conditioning Button. Press the Aircon button to show the aircon control screen. Here you can select the operating mode, set the target temperature and adjust the fan speed. Press the home button to return to the main screen. Note: this button will only be visible if a CI-Bus equipped air conditioner is installed, connected and enabled within the system.</p>
	<p>Fridge Button. Press the fridge button to show the fridge control screen. Here you can select the operating mode, set the cooling setting and view the temperature status. Press the home button to return to the main screen.</p>
	<p>Settings Button. Press the settings button to show the general settings screen. Here you can set the date & time, screen brightness and screen on time. There are also buttons on this screen to pair a Bluetooth device, delete Bluetooth devices, or turn the key beep on / off. Press the home button to return to the main screen.</p>

SWIFT COMMAND POWER CONTROL SYSTEM

8.2.7 Control Panel 'Header' Information

At the top of the control panel screen there is a header or information bar which remains visible on all screens. This is designed to provide quick reference information available at all times



Internal and external temperature in degrees Celsius	Relative humidity	Current date	Current time	*Leisure battery status	*Vehicle battery status
range 1 to 100% The internal temperature is shown inside the vehicle symbol.				Green = good, Orange = fair, Red = poor. Lightning symbol indicates charging from the 230V battery charger	Green = good, Orange = fair, Red = poor. Sun symbol indicates charging from the solar panel.

*When a battery is not being charged a % remaining figure will be displayed. This figure is calculated from the battery voltage and therefore should be used for guidance only.

2.8 Temperature Readings

The EC800 system uses two sensors to measure internal temperature and humidity, and external temperature. The internal temperature and humidity sensor is furniture mounted within the caravan, and the external sensor is mounted below the caravan floor. The figures displayed are for information only, and it is hoped the information will be useful, for example when checking temperatures remotely during cold weather.

For vehicles fitted with Alde or Truma heating systems, this sensor is not used to control the heating temperature as it is measured above the door by the Alde or Truma room sensor. The readings on the heating system may vary relative to the one shown on the EC800 control panel.

For vehicles fitted with a Whale heating system, the sensor is used to control the heating temperature as this system does not have its own sensor.

8.2.9 Water System Operation

The EC800 control panel pump button operates the internal water pump drawing water from an on-board tank if fitted, or an external container when no tank is fitted.

The system incorporates an automatic tank fill feature. When turned on this will automatically fill the on-board water tank from the external container and will switch off automatically when full. To enable tank fill, select 'Fill Tank' on the control panel Water screen. To ensure the external pump is not damaged if the external tank runs dry, the pump runs for a maximum of 7 minutes.

The water tank incorporates a level warning feature to warn the user when the fresh water level drops below 25%. A warnings can be enabled / disabled on the control panel water screen.

If the water pump power is turned on and the fresh water level drops to below 25% a warning beep will be heard and a message will be displayed on the control panel. To cancel the warning, press the confirm button.

These warnings will not be repeated unless the water pump power switch is turned off and on again. This is to ensure the warning does not become a nuisance.

Water Tank Screen

Here you can view the on-board water tank levels and control water tank related features.

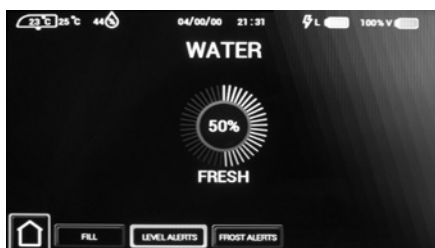

Fill Tank

Press the tank fill button to turn on / off the filling of the on-board water tank from the external water container. The pump will turn off automatically when the onboard tank is full or after 7 minutes have elapsed.

Level Alerts

Press the level alerts button turn on / off the water tank empty warning

Frost Alerts

Press the frost alerts button turn on / off the frost warnings.

8.2.10 Lighting & Dimming Operation

The system contains up to two dimming channels for groups of lights which can be dimmed, turned on and turned off by this screen, and can also be turned on and off by furniture mounted switches.

The awning light can be controlled by a number of items within the caravan, the local switch adjacent to the entry door (if fitted), the alarm system lighting button, the control panel awning light button and the App. Each item can toggle the light on or off.

The Swift Command App can be used to both configure and adjust the lighting and dimming.

Lighting Screen

Here you can turn on / off or adjust the dimmable lighting levels.



On / Off

Press the centre of either dial to turn the dimmer channel on or off. In the off state the centre of the dial shows the word OFF. In the on state the level value is shown.

Up / Down

Press the (+) or (-) buttons to increase or decrease the dimming level.

SWIFT COMMAND POWER CONTROL SYSTEM

8.2.11 Solar Charge Management

The EC601/602/652/653 PSU incorporates a built-in solar charge management feature, which will monitor the input from a separate solar panel and regulator. The Solar Active symbol will be displayed on the control panel when there is an amount of energy available to charge the battery.

The voltage and current produced from the regulator can be viewed on the control panel display by selecting the Power menu item.

Power Screen (12V)

Here you can view battery levels, view charger and solar current and press the more button (right arrow) to view 230V current.



Selected Battery
Use the selected battery button to select which battery you wish to use or charge with the 230V charger. The vehicle battery will only be available when the caravan is plugged into the car.

230V Charging
If a battery is being charged by the 230V charger a 'lightning' symbol will be shown below the dial and adjacent to the relevant battery in the header area.

Solar Charging
If a battery is being charged by the solar panel a 'sun' symbol will be shown below the dial and adjacent to the relevant battery in the header area.

<p>Leisure Dial</p> <p>The leisure dial shows the voltage of the leisure battery. Press the centre of the dial to change to showing the leisure battery current (+ positive value is charging and - negative value is discharging)</p>
<p>Vehicle Dial</p> <p>The vehicle dial shows the voltage of the vehicle battery (when connected). Press the centre of the dial to change to showing the vehicle battery current (+ positive value is charging and - negative value is discharging)</p>
<p>Solar Dial</p> <p>The solar dial shows the current being supplied to the system from the solar panel (if fitted).</p>

8.2.12 AC Current Limiter Operation

The power control system features a 230V current monitoring system which allows the mains hook up current to be displayed on the control panel. The resolution of this reading is 0.5A. A current limit setting can be activated which if reached will switch off the electric elements in the heating system (and air-conditioning if fitted and enabled), until such time as the current drops and the elements will be switched back on.

An example of this is if a kettle was to be operated whilst the heating was on and the current limit was reached then the heater electric element would be temporarily switched off, when the kettle had boiled then the heater element would be switched back on automatically.

This feature is particularly useful when abroad on a low current supply. Setting the value to OFF will disable this feature.

Power screen (230V)

Here you can view the 230V current and set the 230V current limiter.



AC Current

The dial on the left shows the 230V AC current being used by the vehicle (from the site hook-up).

Set Limit

Press the centre of the dial to turn the AC current limiter on or off. Press the (+) or (-) buttons to increase or decrease the limit level. When on, the system will monitor the incoming AC current and if the set limit is reached the 230V heating element within the heating system will be temporarily turned off until the current falls below the set limit.

Note: For this feature to work correctly the Heating mode must be set to Timer so that the system can control the heating appliance.

8.2.13 Heating Controls

There are a number of heating systems that can be controlled by the power control system. The system will be preconfigured by the manufacturer or supplying dealer. The related control panel screens are shown below.

Heating screen

Here you can control the heating system, select energy and temperature and by pressing the more button (right arrow) you can set related timers.



Mode

Set the mode to Manual to use the controls supplied by the heating appliance manufacturer. Set the mode to Timer to control the appliance by the EC800 control panel.

Note: The mode will automatically change to App when you control the appliance by the Swift Command app.

Status Temp Water

The status box shows you which timer is currently active, and the temp and water boxes show the target room temperature and water heater setting for the active timer.

Override

When operating in timer mode you can temporarily 'override' the timer room temperature by using the override feature. Press the centre of the dial to turn the override on / off. Press the (+) or (-) buttons to increase or decrease the required temperature.

SWIFT COMMAND POWER CONTROL SYSTEM

Note: You can also override the room temperature by making a change using the appliance control panel (Alde & Truma only). If you make a change the override will automatically activate. The override temperature will continue until the next timer event time.

Truma CP+ Energy



Truma CP+ Energy
 The energy, gas or electric setting will vary depending on the appliance type.
 For Truma Combi+ heating press the energy button to step through the available settings. Gas is indicated by the flame symbol and electric indicated by the lightning symbol. Possible combinations are GAS, MIX1, MIX2, EL1 or EL2. One electric symbol=1KW and two=2KW.

Alde 3020 Gas / Electric



Alde 3020 Gas / Electric
 For Alde 3020 heating system press the gas button to enable or disable the use of gas. Press the electric button to step through the available electric settings. Gas is indicated by the flame symbol and electric indicated by the lightning symbol. Possible combinations are electric OFF, 1KW, 2KW or 3KW and gas ON or OFF. One electric symbol=1KW, two=2KW and three=3KW.

Whale Air Heater & Water Heater



Whale Air Heater & Water Heater
 For Whale air and water heating press the air or water energy buttons to select the required energy source for the relevant appliance. Gas is indicated by the flame symbol and electric indicated by the lightning symbol. You can select a mix of gas and electric for the water heater. Possible combinations for the water heater are OFF, GAS, EL1, EL2, MIX1 or MIX2 and for the air heater are OFF, FAN, GAS, EL1, EL2 or EL3. See the Whale user manual for power ratings for each setting.

Note: Changes made on the EC800 control panel may not be accepted on the heating controller immediately if the controller has been recently used and still has its backlight on. Please try to use one controller at a time.

Heating timer screen

On the heating screen press the more button (right arrow) to set or view the daily heating timers.



Timer

Press on the hour or minute value to change the setting. Timers should be set in order during the day (Timer 1 the earliest and Timer 4 the latest) and use the 24 hour clock.

Temperature

Press the temperature values to change the setting. Each press will increment the value from Off, then 5 degrees through to 30 degrees Celsius.

Water

Press the water values to change the setting. Each press will step through the available setting, which vary by appliance type.

For Truma CP+ available settings are Off, Eco or Hot.

For Alde 3020 available settings are Off, Normal or Boost.

For Whale available settings are Off or On.

Note: To use these timer settings the Heating mode must be set to Timer so that the system can control the heating appliance.

Air-conditioning

If your vehicle has been fitted with a compatible air-conditioning unit then the settings can be set / controlled by the EC800 control panel, the air-conditioner infrared remote control or the Swift Command app. The unit must be turned on with its power switch before it can be controlled.

The related control panel screens are shown below. For information in using the air-conditioning from the Swift Command app, please see the Swift Command User Guide.

Air-conditioning screen

Here you can select the operating mode, set the target temperature and adjust the fan speed.



Lights

Press the lights button to control the LED light built into the air-conditioning unit. Select on or off to turn the light on or off, or select dimmed to allow the light to be controlled with other dimmable lighting in the vehicle.

Mode

Press mode button to select the required operating mode. Select off to turn the air-conditioner off. Note that available modes vary according to the model of air-conditioner fitted.

Temperature

Use the temperature setting (+) or (-) buttons to increase or decrease the temperature setting. Available settings range from 5 degrees to 30 degrees Celsius.

Fan Speed

Use the fan speed setting (+) or (-) buttons to increase or decrease the fan setting. Note that available settings vary according to the model of air-conditioner fitted.

SWIFT COMMAND POWER CONTROL SYSTEM

8.2.14 DAB / FM Radio

Radio screen

Here you can select the radio mode, scan for stations, tune or adjust the volume.



Mode
Press the mode button to select the required radio mode, available choices vary by specification and include FM, DAB, Aux 3.5mm input or Off. Select Off to turn the radio off.

Scan
Press the (<) or (>) buttons to scan forward for the next station or to scan backwards for the previous station.

Tune
Press the (+) or (-) buttons to increase or decrease tuned frequency.

Note: Aux can be used when a device is connected to the radio module using the 3.5mm jack plug, either on the side of the radio module or on the binnacle at the front of the caravan (depends on model specification).
Set the device volume to a mid-setting and then adjust on the EC800 control panel. If the sound level is too low increase the device volume, or if the sound is distorting reduce the level.



Volume
Press the (+) or (-) buttons to increase or decrease the volume level. Press on the centre of the dial to mute the volume, press again to restore the volume level.

Preset
The 5 pre-set buttons are used to store and retrieve your favourite stations. To store a station, firstly scan or tune to the required station, then press and hold the pre-set number until you hear a beep. To retrieve a station simply press the required pre-set button.

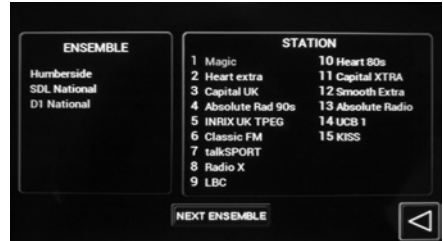

DAB Channel List
When using the DAB radio, the channels are grouped into ensembles. You can scan for channels within an ensemble by pressing the (<) or (>) button.
You can also press on the central channel information window to show a full list of ensembles and their channels. Press the next ensemble button to scan for channels in the next available ensemble.
You can select an ensemble by pressing on it in the left side list. You can select a station by pressing on it in the right side list. Press the < button to return to the radio screen.

Note: DAB reception may be temporarily interrupted by poor signal or when using electrically 'noisy' equipment or appliances (for instance hob ignition).

Audio screen

On the radio screen press the more button (right arrow) to access the audio settings. Use the additional slider controls to adjust the levels.



Tone

Use the slider bars to adjust the treble, middle or bass levels.

Loudness

Use the loudness slider to further adjust some audio frequencies to suit requirements.

Balance

Use the balance slider to adjust the levels between the left and right speakers.

Fader

For installations with 4 speakers, use the fader slider to adjust the levels between the front and rear speakers.

8.2.15 Refrigerator controls

The main refrigerator settings can be set / controlled by the EC800 control panel or the Swift Command app. These controls work in parallel with the ones on the fridge control panel, so the settings can be changed by either method.

The related control panel screens are shown below.

For information in using the fridge from the Swift Command app, please see the Swift Command User Guide.

Fridge screen. Here you can select the operating mode, set the cooling setting and view the temperature status.



Mode

Press mode button to select the required operating mode. Select off to turn the fridge off.

Setting

Use the setting (+) or (-) buttons to increase or decrease the cooling setting. 1 is low and 5 is maximum.

Temperature

The temperature status display shows the temperature state of the fridge, with the optimal (central) position being the ideal. If the fridge is too warm, increase the cooling setting to reduce the temperature. If the fridge is too cold, reduce the cooling setting accordingly.

Note: The fridge will take time to react to a setting change so please allow sufficient time for the status to update after changing a setting or adding food.

SWIFT COMMAND POWER CONTROL SYSTEM

8.2.16 Bluetooth Pairing & Other Controls

The EC800 control panel can display the software version number of the Control Panel, the PSU and the communicator / tracking unit. Press the settings button to view the setting screen which contains the related information.

The Bluetooth pairing process is covered below. Further help with Bluetooth pairing is available in the form of a help video which can be viewed on the Sargent website in the Support Information section.

General settings screen

Here you can set the date & time, screen brightness and screen on time.



Time, Date & Day

Press the (+) or (-) buttons above or below each item to adjust the value. Note that the system uses the 24 hour clock.

Screen settings

Press on the screen brightness button to adjust the screen backlight level. Press on the screen timeout button to select the time that the screen will stay illuminated for after a press or touch.

Bluetooth Pair

Press the pair button to start pairing with your compatible Bluetooth device. The pair button border will illuminate when pairing is active. You can now pair your device to the system following the devices instructions. Pairing remains active for 1 minute and is then turned off automatically.

Bluetooth Delete

Press the delete button to delete any Bluetooth pairings from the system.

Key Beep

Use the key beep button to turn on / off the beep sound when a button is pressed.

Note: Setting changes are saved when you press the home button to return to the main screen.

8.2.17 AL-KO ATC Operation

On caravans fitted with AL-KO Trailer Control, the Swift Command App can be used to monitor the status of the ATC from within your tow vehicle. More information on this can be found within the Swift Command App and the associated user guide.

Note: If using the Swift Command app to monitor the ATC whilst driving the phone or device must be placed in a suitable holder and setup before driving. At all times ensure you obey the legal requirements for using mobile devices in vehicles.

8.2.18 System Warnings

The system incorporates a number of warnings that are active at specific times. These are summarised below, and also covered by relevant sections of this manual.

When a warning is active a warning box will appear on the control panel screen containing a description of the warning along with an audible beeping sound.

Warning	When	Type
Fresh water level low	With pump turned on and fresh water level low (less than 25% full) Only available when an on-board tank is fitted.	Message on screen and 60 second audible beep
Waste water level full	With pump turned on and waste water level full. Only available when an on-board tank is fitted	Message on screen and 60 second audible beep
Leisure battery voltage low	With control panel power on and leisure battery selected (as active battery) and the voltage level falls below 10V	Message on screen and 60 second audible beep
	With control panel power on and leisure battery selected (as active battery) and the voltage level is below 9V	Message on screen and 60 second audible beep. If no action taken after 30 seconds then the system will switch the power off to prevent severe discharge of the battery
	<p>Note: This is an emergency cut off level to protect the battery from severe damage. You should not rely on this cut off level during normal operation, but manage your power consumption to a discharge level of 11.5V or above.</p> <p>This cut off only applies to power drawn from the battery by the leisure equipment that is controlled by the control panel power switch; it will not protect the battery from discharge by permanently connected equipment.</p>	
Leisure battery voltage high	With control panel power on or off and leisure battery is selected (as active battery) and the voltage level rises above 15V	Message on screen and repeated beeps from the control panel. The power is automatically turned off. The beeping will not stop until the fault is cleared.
Vehicle battery warnings	If the vehicle battery is selected instead of the leisure battery, then similar warnings to those described above are applied to the vehicle battery. The vehicle battery low warning level is 10.9V	
Engine running	When the engine is started the system power will be turned off	Message on screen stating 'engine running'.
Step extended	Step extended and engine started	Message on screen and warning buzzer
	Step jammed or obstructed	

SWIFT COMMAND POWER CONTROL SYSTEM

Warning	When	Type
Mains lead (hook-up cable) still connected / plugged in	When the engine is started and the mains cable is still plugged in and the charger is switched on	Message on screen and repeated beeps from the control panel. The beeping will not stop until the hook-up lead is removed.
Waste water level full	When set to control the heating system, the EC800 control panel will show related heating system warnings, which will include the error number and error description	Message on screen and 60 second audible beep. Additional descriptive information is available when using the Swift Command App.
Refrigerator / Fridge Freezer	When set to control the refrigerator, the EC800 control panel will show related warnings which will include the error number and error description	Message on screen and 60 second audible beep. Additional descriptive information is available when using the Swift Command App.

8.3 System Technical Information

The following section provides further technical information relating to the electrical system.

You can also access the supporting technical manual from www.sargentltd.co.uk

8.3.1 Residual Current Device & Miniature Circuit Breakers

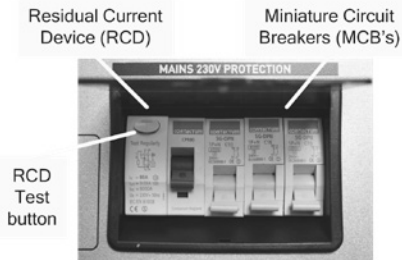

The Residual Current Device (RCD) is basically provided to protect the user from lethal electric shock. The RCD will turn off (trip) if the current flowing in the live conductor does not fully return down the neutral conductor, i.e. some current is passing through a person down to earth or through a faulty appliance.

To ensure the RCD is working correctly, the test button should be operated each time the vehicle is connected to the mains supply (see section 2.3)

The Miniature Circuit Breakers(MCB's) operate in a similar way to traditional fuses and are provided to protect the wiring installation from overload or short circuit. If an overload occurs the MCB will switch off the supply. If this occurs you should investigate the cause of the fault before switching the MCB back on.

The following table shows the rating and circuit allocation for the three MCB's

MCB	Rating	Output Wire Colour	Description
1	10 Amps	White	230V Sockets
2	16 Amps	White (Yellow for heater)	Extra 230V Sockets / Heating System
3	10 Amps	Black (Blue for Whale water heater)	Fridge / Charger / Auxiliary devices / Whale Water Heater

8.3.2 Generator Usage

Caution should be used before connecting a generator to your caravan.

⚠️WARNING: Never start or stop the generator while electrical loads are connected and switched on. Start the engine, let it stabilise and then connect the electrical load. To stop the engine, disconnect the electrical load and let engine stabilise before switching off

Whilst some generators use electronic inverter technology, others use a more basic principle to generate the 230V supply. Preference should be to choose a generator which produces a consistent sinusoidal wave form with accurate voltage control.

The Reverse Polarity warning light on the PSU may illuminate when using a Generator.

This is a normal side effect when using some types of generator. Instead of connecting the neutral conductor to earth, some generators centre tap the earth connection making both neutral and live conductors 110V above earth.

This 110V difference causes the neon polarity indicator to illuminate.

In most cases it is safe to use a generator, but please consult the generator handbook for further information.

SWIFT COMMAND POWER CONTROL SYSTEM

8.3.3 Battery Charger

The system incorporates an intelligent three-stage battery charger.

During stage 1 the battery voltage is increased gradually while the current is limited to start the charging process and protect the battery. At stage 2 the voltage rises to 14.4V to deliver the bulk charge to the battery. When the battery is charged, the voltage is decreased at stage 3 to 13.6V to deliver a float charge to maintain the battery in the fully charged state. The charger can be left switched on continuously as required.

The battery charger / power converter also provides power to the leisure equipment when the mains supply is connected. This module supplies DC to the leisure equipment up to a maximum of 25 Amps (300 Watts), therefore the available power is distributed between the leisure load and the battery, with the leisure load taking priority as per the following example:

Leisure Load	Available power for battery charging
5A	20A
10A	15A
15A	10A
20A	5A

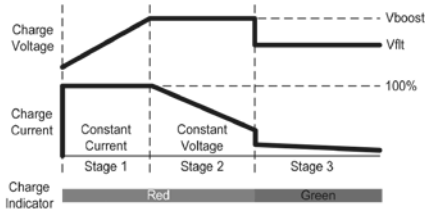

⚠️ WARNING: Under heavy loads the Battery Charger case may become hot. ALWAYS ensure the ventilation slots have a clear flow of air. Do not place combustible materials against / adjacent to the charger.

8.3.4 Leisure Battery

A) Type / Selection

For optimum performance and safety it is essential that only a proprietary brand LEISURE battery is used and it is suggested to select a battery from the NCC Verified Battery Scheme with a typical capacity of 75 to 120 Ah (Ampere / hours). Depending on the prospective use of the vehicle the correct type should be selected (A, B or C). A normal car battery is NOT suitable. This battery should always be connected when the system is in use.

The PSU is configured to work with standard lead acid leisure batteries, and in most cases is also compatible with the latest range of Absorbed Glass Matt (AGM) batteries. The system is also suitable for Lithium batteries with built-in Battery Management Systems BMS). Before fitting non-standard batteries please check that the charging profile described in 3.3 is suitable for the type of battery by referring to the battery documentation or battery manufacturer.

Some vehicle installations can cater for two leisure batteries connected in parallel. In these cases it is recommended that two identical batteries are used. The battery feed is fitted with an inline fuse between the battery and the electrical harness, and is usually located immediately outside the battery compartment or within 500mm of the battery. The maximum rating of this fuse is 20A per battery.

B) Installation & Removal

Always disconnect the 230V mains supply and turn the PSU green charger switch to the off position (button out) before removing or installing the battery.

When connecting the battery, ensure that the correct polarity is observed (black is negative [-] and red is positive [+]) and that the terminals are securely fastened. Crocodile clips must not be used.

⚠️ WARNING: Explosive gases may be present at the battery. Take care to prevent flames and sparks in the vicinity of the battery and do not smoke.

C) Operation / Servicing

Under normal circumstances it should not be necessary to remove the battery other than for routine inspection of the terminals and "topping up" of the battery fluid where applicable. Please see instructions supplied with the battery.

Note: Do not over discharge the battery. One of the most common causes of battery failure is when the battery is discharged below the recommended level of approximately 10V. Discharging a battery below this figure can cause permanent damage to one or more of the cells within the battery.

To prevent over discharge, the power control system incorporates a battery protect circuit that warns the users and then disconnects the batteries when they fall below set values.

If a warning is active a beep will be emitted by the control panel and information will be shown on the screen. To cancel the warning, press the select button. These warnings will not be repeated unless the power switch is turned off and on again. This is to ensure the warning does not become a nuisance.

Battery	Voltage cut off	Action after cut off	Notes
Vehicle	10.9V	Battery selection is changed from Vehicle battery to Leisure battery. If the leisure battery is below 9V then a further warning will occur (see below).	This cut off level is designed to protect the vehicle battery from over discharge. The 10.9V level ensures there is sufficient power in the battery to run the vehicle electronics and start the vehicle. This cut off only applies to power drawn from the battery by the leisure equipment; it will not protect the battery if you leave vehicle circuits switched on, such as the road lights.
Leisure	9V	Power is turned off	This is an emergency cut off level to protect the battery from severe damage. You should not rely on this cut off level during normal operation, but manage your power consumption to a discharge level of about 11.5V. This cut off only applies to power drawn from the battery by the leisure equipment that is controlled by the control panel power switch; it will not protect the battery from discharge by permanently connected equipment.

SWIFT COMMAND POWER CONTROL SYSTEM

8.3.5 12 Volt DC Fuses

⚠WARNING: When replacing fuses always replace a fuse with the correct value. NEVER replace with a higher value / rating as this could damage the wiring harness. If a replacement fuse 'blows' do not keep replacing the fuse as you could damage the wiring harness. Please investigate the fault and contact your dealer.

The following table shows the fuse allocation for the 13 fuses fitted to the PSU. Please note that fuses are dependant on PSU versions, so not all fuses may be present.

Fuse	Rating	Fuse Colour	Description
1	25 Amps	White	Charger
2	7.5 Amps	Brown	Permanent 12V / Alarm / Fridge Electronics
3	10 Amps	Red	12V Sockets / TV Amplifier / Radio
4	10 Amps	Red	Extractor Fans
5	5 Amps	Tan	Appliances / Hob Ignition / Toilet/ Whale Water Heater
6	10 Amps	Red	Water Pumps
7	7.5 Amps	Brown	Lighting, Main Lights & Dim Channel 1
8	7.5 Amps	Brown	Lighting, Entry Light & Dim Channel 2
9	10 Amps	Red	Alde Heating / Truma Heating / Whale Air Heater
10	10 Amps	Red	Auxiliary / Awning Light
11	20 Amps	Yellow	Not fitted
12	15 Amps	Blue	Not fitted
13	15 Amps	Blue	Not fitted

ⓘNote: Fuses (2-13) have a Red LED below them which provides indication that the fuse has blown. The charger fuse has a green LED which indicates that the charger is working.

Fuse	Rating	Fuse Colour	Description
Battery 1	20 Amps	Yellow	Fuse remotely located near battery
Battery 2	20 Amps	Yellow	Fuse remotely located near battery 2 (where fitted)

The following table shows details of the fuse(s) located at the Leisure battery.

The following table shows details of the fuse(s) located at the C44 Road Light fuse box.

Fuse	Rating	Fuse Colour	Description
1	20 Amps	Yellow	Fridge Supply
2	5 Amps	Tan	Left Hand Tail Lights
3	5 Amps	Tan	Right Hand Indicators
4	5 Amps	Tan	Fog Lights
5			Spare Location
6	20 Amps	Yellow	Car Battery Supply
7	5 Amps	Tan	Right Hand Tail Lights
8	5 Amps	Tan	Left Hand Indicators
9	7.5 Amps	Brown	Stop Lights
10	5 Amps	Tan	Reverse Lights

8.3.6 Common Fault Table

Fault	Possible Cause	Proposed Fix
No 230 volt output from PSU	Connecting lead between the site and Leisure Vehicle not connected	Check and connect lead as per 8.2.3C
	RCD switched off	Reset RCD as per 8.2.3D
	RCD not operating correctly	Check supply polarity; if the RCD continues to fail contact your Dealer as there is probably an equipment or wiring fault.
	MCB switched off	Reset MCB by switching OFF (down position) then back ON (up position), if the MCB continues to fail contact your Dealer as there is probably an equipment or wiring fault.
	No or deficient supply from site	Contact site Warden for assistance.
	Other fault	Contact your Dealer
Reverse Polarity light is illuminated on PSU	Mains Supply reversed?	The reverse polarity light is designed to illuminate when the Live and Neutral supply has been reversed / crossed over. If the light illuminates there is a problem with the site supply or the cable connecting the supply to your vehicle. The light is designed to work on UK electrical supplies (where the neutral conductor is connected to earth at the sub station). If you are using your vehicle outside the UK this light may illuminate when no fault exists. In these cases consult the site warden for advice.
	Generator being used	'The Reverse Polarity warning light is on when using my Generator'. This is a normal side effect when using some types of generator. Instead of connecting the neutral conductor to earth, some generators centre tap the earth connection making both neutral and live conductors 110V above earth. This 110V difference causes the neon polarity indicator to illuminate. In most cases it is still safe to use the generator, but please consult the generator handbook for further information.

SWIFT COMMAND POWER CONTROL SYSTEM

Fault	Possible Cause	Proposed Fix
Control Panel Problems	Control Panel has no display	<p>Check batteries and fuses, turn PSU isolate switch and charger switch on and ensure mains supply is connected.</p> <p>Check control panel connecting lead at PSU and behind Control Panel.</p> <p>Contact your Dealer.</p>
	12V Power turns off	<p>Battery protect feature has operated to protect the Vehicle battery and or the Leisure battery. See 8.3.4C</p> <p>Over voltage protection has been activated, the control panel will display a warning. A number of things can cause this but the most common is the solar panel, it is worth checking the regulator is connected correctly and operating within the correct parameters.</p> <p>Engine has been started, all equipment has been disconnected to meet EMC requirements. See 8.2.4</p>
	Control Panel locked / erratic function	<p>Observe control panel handling instructions. Control panel software may have crashed. Reboot control panel by turning off the PSU isolate switch. Wait 30 seconds then turn the switch back on. Check with your dealer that your system has the latest software installed, as an update may be available.</p>
No 12 volt output from PSU	No 230V supply	Check all above
	Charger not switched on	Turn charger switch on, switch will illuminate
	Battery not connected and / or charged	Install charged battery as per 8.3.4
	Power button on control panel not switched to on	Turn power on at control panel.
	Battery flat / Battery fuse blown	Recharge battery, check fuses, check charging voltage is present at battery.
	Fuse blown	Check all fuses are intact and the correct value fuse is installed as per fuse table.
	Equipment switched off / unplugged	Check equipment is switched on and connected to the 12V supply
	Other fault	Contact your Dealer

Fault	Possible Cause	Proposed Fix
Pump not working	Fuse blown	Replace fuse with correct value as per fuse table
	Pump turned off	Turn pump on by pressing the pump button at the control panel
Lights not working	Fuse/s blown	Replace fuse with correct value as per fuse table.
	Lights turned off	Turn Lights on by pressing the lights button, use dimmer at the control panel.
Comms not working	Bluetooth not paired	Using System Settings menu, select Bluetooth Pair option
	Bluetooth not active on Device	Ensure that the handheld device has Bluetooth switched on and that the device supports the Bluetooth 4 standard (BLE)
	Bluetooth out of range	Ensure the handheld device is within 7M of the middle of the motorhome

8.3.7 Contact details

Sargent Electrical Services Limited provide a technical help line during office hours. Please contact 01482 678981 if you require technical help.

For out of hour support please refer to the support section of the Sargent web site www.sargentltd.co.uk

8.4 Remote Access & Control

8.4.1 Swift Command App

The Swift Command app can be downloaded from the Apple App Store or the Android Play store.

A separate Swift Command User Guide is available which covers the operation of the app.

Before you can use the App with your caravan you will need to create an account and sign up to the free communication service.

This is a simple process and will be explained further by your dealer at the vehicle handover.

Additional information is available at www.swiftcommand.co.uk

8.4.2 Swift Command Web usage & Description

In addition to the mobile App, you can also use the same account and login details to access the Swift Command web site.

Here you can update and amend your details, look at location information and history, review system information and historical data as well as changing some system options and settings.

8.4.3 Swift Command SIM Coverage & Usage information

The EC600 system contains a Mobile SIM with a 36 month contract, which commences upon activation at the Dealership when your vehicle is linked to your account.

Below is a list of the countries covered by the SIM under a fair usage policy, a complete list is available at request.

Austria, Belgium, Bulgaria, Cyprus, Czech Republic, Denmark, Estonia, Finland, France, Germany, Greece, Hungary, Iceland, Ireland, Italy, Latvia, Liechtenstein, Lithuania, Luxembourg, Netherlands, Malta, Norway, Poland, Portugal, Romania, Slovakia, Slovenia, Spain, Sweden, United Kingdom.

For vehicles shipping direct to Australia or New Zealand a special world-wide SIM is fitted at the Swift factory.

Please note that if a UK specification vehicle is shipped to these countries the remote features will not operate.

8.4.4 Replacement parts

The Control panel contains a small lithium battery to maintain the clock when no other energy supplies are available this will last in excess of 5 years under normal conditions. The battery is a CR2032 3.0V The EC630 Communication module contains a special backup battery pack which should last in excess of 3 years under normal conditions. The pack part number is 16308 available from Sargent.

8.4.5 Updates

From time to time there may be updates to the system firmware; these updates will be done at service intervals by your dealership.

8.5 Technical Data & Approvals

8.5.1 Equipment – EC601, EC602, EC800, EC635 & PX300

Outline Specification		
INPUT 230V	230 Volts / 0 to 16 Amps	+ / - 10%
OUTPUT 230V	RCD protected, 2 x MCB outputs of 10A & 1 x MCB output of 16A Separate switched channels for heating system and charger	
INPUT 12V	2 x 20A battery inputs via 2 x 4 way connectors	
SOLAR INPUT	1 X Dedicated solar panel input capable of supporting 10A of solar power input (typically 180 to 200W) via a 2 way connector	Check the solar panel rating plate to ensure the maximum current is <= 10A
OUTPUT 12V	25A total output via multiple switched channels protected by 13 fused outputs	
Integrated CHARGER	Input 220-240 Volts AC +/- 10%, Frequency 50 Hz +/- 6%, Current 3A max. DC Output 13.6 to 14.4 Volts nominal, Current 25 Amps max (300 Watts).	
Signal INPUT	4 x Fresh water level, 4 x Waste water level, 1 x Engine running, plus multiple vehicle connections, sensor inputs for temperature & humidity	Fresh water negative sensed Waste water negative sensed
Data IN / OUT	CANBUS Data communication and power to Control Panel via 6 way connector Ci-Bus Data communication to Ci-Bus enabled devices via RJ11/12 connector	
IP rating	IP31	
Operating temperature	Ambient 0 to 35° Celsius Charger case temperature with full load 65° C Max	Automatic shutdown and restart if overheated / overloaded
Dimensions		
EC601, EC602, EC652 & EC653 PSU	Overall size (HxWxD) 180 x 305 x 135mm Clearances 75mm above, 50mm left & right	Weight 3.8 Kg
EC800 Control Panel	Overall size (HxWxD) 125 x 279 x 25mm Cut-out size (HxW) 108 x 173mm + switch area	Fixing centres 250mm X 74mm Weight 380g
EC635 Comms Module	Overall size (HxWxD) 55 x 116 x 85mm	Weight 550g
EC840 Sensor	Overall size (HxWxD) 20 x 35 x 38mm	Weight 10g

8.5.2 Approvals

System: BSEN 1648-1, BSEN1648-2
compliant, BS7671: 2008 compliant

Residual Current Device: RCD 40A 30mA trip
to BS EN 61008

Miniature Circuit Breakers: MCB's type C
6000A breaking capacity to BSEN 60898

Electro Magnetic Compatibility (EMC)

directive: 2004/108/EC Certificate
CE20071224-1

Integrated Charger: BS EN 60335-1/2.29,
2006/95EC, IEC61000-3.2/3:1995, 1.

Low Voltage Directive: 2006/95EC TUV-
014900-A1, EN55022, Class B, EN55024/
Level 2

8.5.3 Declaration of Conformity

Equipment: Leisure Power Control System

Model name: EC601, EC602, EC800, EC635
& PX300

I hereby declare that the equipment named above has been designed to comply with the relevant sections of the above referenced approvals. The unit complies with all essential requirements of the Directives.

Signed	Name	Position	Manufacturer
Date	I L Sargent	Technical Director	Sargent Electrical Services Ltd Unit 35, Tokenspire Business Park Woodmansey, Beverley East Yorkshire, United Kingdom

Whilst every effort has been made to ensure the accuracy and completeness of this document, no guarantee is given against errors or omissions. This document may be updated / improved over time therefore please check with your dealer / supplier for update information or visit www.sargentltd.co.uk

Heaters and boilers	120
Whale water heater / space heater	120
Truma combi boiler	122
Alde compact 3020HE boiler	128
Alde flow	130
Thermostatic mixer valve	130
Dometic absorbtion refridgerator	131
Cooking appliances	132
Microwave	133
Toilet	135
External BBQ point	136
External shower point	137
Status Directional TV	138
TV inlet in battery box	139
Entertainment equipment	140
Bedding configurations	141
Exterior door	145
Windows	147
Roof lights	147
Onmi-vent and fan operations	150
Tables	151
Awnings	153
TV brackets (when fitted)	154
Cycle racks	154
Digital reversing rear view camera (if fitted)	155

HEATERS AND BOILERS

Note: The instructions covering fitted equipment to your caravan were correct at the time of going to print, and where possible, hyperlinks and QR codes have been used, which provide links to online versions of user instructions. Owners handbooks are updated annually and we take great care to try and ensure their accuracy. However, the Swift Group Limited cannot accept responsibility for any changes that may be made in specification or operating instructions to the equipment described in this section after the time of going to press.

Every care is taken to ensure that the information provided in this handbook is correct and easy to understand.

Separate manufacturers' instructions for the majority of fitted equipment are also included in the Owner's Pack provided with this caravan. It is essential that these are read and understood before using the equipment for the first time.

If you are in any doubt as to how to operate the equipment in your caravan, please contact the component manufacturer's service department on the telephone number shown on their component leaflet. If you remain in any doubt, please contact your supplying dealer.

Note: In the interest of safety, replacement parts for an appliance shall conform to the appliance manufacturer's specifications and should be fitted by them or their authorised agents.

9. Heaters & Boilers

Electrical operation

To operate the heaters and boilers on 230v the isolation button on the Sargent Power Supply unit must be switched ON, as shown in the image below. To confirm a supply is available, the button will be illuminated when a power supply (mains hook up) is connected and the button is ON.

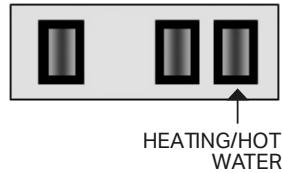

9.1 Whale Water Heater (Basecamp)

Whale eight litre gas / electric water heater.

CAUTION: Never operate the Whale water heater without water in it. Please ensure the water system is primed (water heater drain valve closed, and water system filled with water), and that the vehicle is level, before operating the water heater

Quick reference and detailed instructions are available for the water heater, please read these before using the water heater. They are available at:

http://www.whalepumps.com/rv/resources-library.aspx?Application_listItem_ID=11394



If you are unable to view the documents on line, please contact the supplier, your dealer or Swift for an electronic or paper copy.

Whale water heater drain valve

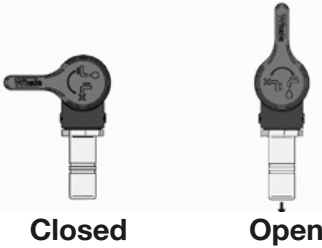

Electrical operation of Whale Water Heater

Once the water system is primed, the 230v isolation button on the Sargent Power Supply unit can be switched ON, as shown on page 120 (8.1).

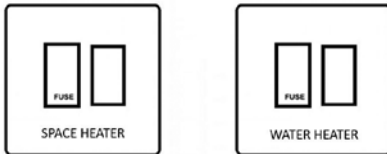

In addition, in the base of the wardrobe are two switched fused spurs which individually isolate the 230v supply to the Whale space heating and water heating appliances. These will be labelled Space Heater and Water Heater, and once the water system is primed, the switch marked WATER HEATER must also be switched ON for electric water heating.

Whale Space Heater (Basecamp)

Whale underfloor gas / electric space heater. Quick reference and detailed instructions are available for the space heater, please read these before using the heating system. They are available at:

http://www.whalepumps.com/rv/resources-library.aspx?Application_listItem_ID=11394



If you are unable to view the documents on line, please contact the supplier, your dealer or Swift for an electronic or paper copy.

Electrical Operation of Whale Space Heater

For switching on the electrical connection see electrical operation of Whale Water Heater

Troubleshooting

The Space Heater is equipped with an electronic diagnostic system which will detect fault conditions ranging from poor gas or d.c. supply to internal Space Heater malfunctions. In the unlikely event of a failure, the red LED on the Control Panel will light.

In the unlikely event of a failure, the red '!' LED on the Control Panel will light. To identify the lockout press and hold the Space Heater Function Button. The temperature control bars will light to indicate the fault code e.g if 1 bar lights, the fault code is one, if 2 bars light, the fault code is 2 etc. Please refer to the note below.

Note: To clear a lock out. If 1, 3, 4 or 5 bars are lit indicating a lockout - turn the d.c. power 'off' and then 'on' again at the vehicle's power supply unit. If this does not clear the lockout, or any other lockout is displayed (i.e. 2 or all 12 bars lit) - please press the red Reset Button on the Water Heater once for one second.

If the problem persists contact:

Whale's Support on +44 (0)845 217 2933.

Warranty

WHALE® is a registered trademark of Munster Simms Engineering Ltd (also trading as Whale®).

The Whale® Space Heater is covered by a 3 year warranty. Please complete the enclosed warranty card and return to Whale.

For warranty details, please see the enclosed warranty statement.

Munster Simms Engineering Ltd.
2 Enterprise Road, Bangor
N. Ireland
BT19 7TA

Tel:+44 (0)28 9127 0531
www.whalepumps.com
Email: info@whalepumps.com

9.2 Truma Combination Boiler



The Truma Combination Boiler can be used in the following ways:

To provide combined room heating and water heating.

- Simultaneous heating of the room, and water contained within the appliance. Often referred to as Winter Mode.

To provide water heating only.

- Heating of the water within the appliance, without room heating. Often referred to as Summer Mode.

To provide room heating only, without water heating.

- If the water system has not been primed, meaning that there is no water within the appliance, it is still possible to use the Combination Boiler to heat the room.

Dual Fuel operation

The Truma Combination boiler has been designed to run on gas or electric power, and the optimum performance is obtained when used in dual fuel mode, that is running on gas and electric at the same time.

Running in dual mode has the following benefits:

- The fastest possible heat up time, as the gas burner combines with an electric element to provide energy to heat your hot water and warm your caravan.

- The intelligent heat management system automatically senses when the water and room are nearing the required temperature and then automatically turns off your gas burner and operates solely on electric power, conserving your gas.
- As hot water is used or the room cools the Truma combination heater will continue to operate on electric only, until a point where the demands necessitate that additional gas power is also required. An example for such a demand could be for instance if the exterior door was left open and the room temperature dropped by 10 degrees in the space of a few minutes, in this case the intelligent heat management system would decide the best way to get the room back to the required temperature, would be to use both gas and electric at the same time.

Operating the Truma Combination system on electric or gas only will result in longer heat up times for hot water, and room temperature, in comparison to operating on dual fuel.

Operating on electric only may not in all cases maintain a comfortable room temperature especially in colder conditions.

Whilst taking energy consumption and the environment into account, consider using the Combi in Summer mode (water heating only) when room or space heating is not required, but may be needed in the near future. This ensures the appliance is held at the same temperature as the hot water setting chosen, and this can reduce the time taken to provide warm air into the living area, when room or space heating is then selected.

Truma Heating System and Air Flow

The Swift Group undertakes considerable testing of our products in cold chambers to ensure they meet the BS EN 1649 Grade 3 standard and are usable in cold temperatures.

Butterfly outlets

The majority of air ducting outlets on models equipped with Truma Combi heating systems, are of the butterfly type. These may be opened or closed by moving the flap within the fitting, to adjust the balance of the heating output throughout the caravan. This can help offset differences in blown air output, between

outlets close to the heating appliance, and those greater distance away from the heating appliance. This can also help adjust the temperature of the bathroom, relative to the temperature of the main living area and/or bedroom.

When these butterflies are closed in conjunction with a high heating system output, and therefore a high fan speed, a slight whistling sound can occur. In this case, opening the outlet slightly will reduce or remove the noise.

Closing too many outlets when the heating system is producing a high output, can cause the appliance to reach high operating temperatures. This does not in general terms affect the appliance, but can cause the appliance to automatically shut down. This can cause an interruption of the heating of the caravan, however heating will resume when the appliance temperatures have reduced to a lower level.

The output of the appliance, and therefore the output of the blown air outlets, will generally be higher when using Gas or Dual Fuel operation. Electric only operation of the heating is rated at up to 1.8kW, whereas Gas (or Dual Fuel) operation is rated up to 4kW (3.8kW) or 6kW (5.8kW), depending which model or Combi is fitted.

The blown air fittings can also be rotated to adjust the direction of air leaving the outlet, as shown in the photo.

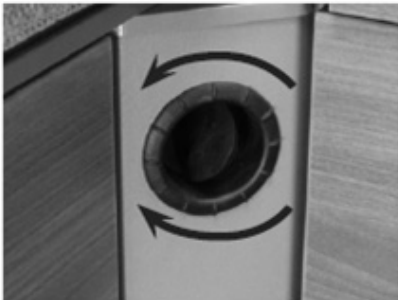

Truma Combination Boiler Control Panel and Appliance Instructions

Please read the user instructions before using the heating system. The instructions include warnings regarding the safe use of the system, and no liability whatsoever can be accepted for damage or injury resulting from failure to observe the instructions.

The heating system can be controlled by a Truma CP+ controller, or the Swift Command control panel, App., or remote control system.

For Swift Command functions please see the Swift Command literature and details within this handbook.

For use of the CP Plus controller, and general user instructions for the heating system appliance, please read the Truma information available at the following locations:

CP Plus Controller

https://www.truma.com/downloadcenter/cp_plus_installation_operating_de_gb_fr_it.pdf



Combi 4 Gas/Electric and Combi 6 Gas/Electric appliances

https://www.truma.com/downloadcenter/combi_e_cp_plus_ready_operating_de_gb_fr_it_nl_dk_se.pdf



Electrical Operation of Truma Combination Boiler

Before the heating system is used for heating using electrical (230v) energy, the 230v isolation button on the Sargent Power Supply Unit must be switched ON, as shown on page 120 (8.1)

Troubleshooting instructions (Combi heater)

In the event of a problem occurring, a warning or error code will be displayed on the Truma CP Plus control panel, along with a warning triangle. Further warning information will also be displayed on the Swift Command control panel.

The Truma combi boiler (heater and water) has two styles of error code warnings which are shown on the CP+ display panel. Depending on the nature of the fault, the boiler will require resetting in a slightly different manner, depending on the fault.

- Solid error warning code
- Flashing error warning code

Before trying to reset any faults please check that the 12v supply is on, and depending on which energy source is going to be used for heating, either mains electricity is available and switched on, and/or that the gas bottle is open and ready to dispense gas.

The following table on the next page describes causes and remedies to the various fault codes that may be displayed on the Truma control panel.

Once the fault has been rectified the fault can be reset via the control panel

Solid code

- Using the control dial on the cp+ panel scroll down to the bottom line where the triangle appears.
- Press this button to acknowledge the error
- The error code and triangle should disappear if the fault has been rectified

Flashing code

- Scroll round (as above) to acknowledge the error on the panel
- Leave the panel UNTOUCHED for 15 minutes
 - This allows the user to check that fuel sources are available, and is a regulatory time frame

- After 15 minutes the triangle will become solid
- The panel can be reset as per the above process for SOLID

If the CP+ panel is reset 5 times, without the fault being rectified the fault will become a 'FLASHING' CODE and will be locked for 15 minutes. If the control panel (cp+) is touched within 15 minutes, the 15 minute 'count' will restart. It is imperative that the panel is left untouched during this time.

Truma Customer Service can be contacted on 01283 587960 or technical@trumauk.com if you require further assistance.

Error code	Cause	Remedy
#17	Summer mode with empty water container	Switch device off and allow to cool. Fill boiler with water
#18	Warm air outlet blocked	Check each of the outlet openings
	Circulated air intake blocked	Remove the blockage from the circulated air intake
#21	Room temperature sensor or cable faulty	Inspect the room temperature sensor cable, replace if faulty
		Check the resistance of the room temperature sensor. 15°C – 16.2 kOhm / 20°C – 12.6 kOhm / 25°C – 10.0 kOhm Replace the room temperature sensor if faulty
#24	Risk of low voltage. Battery voltage is too low < 10.4 V	Charge battery
#29	Frost Control heating element has a short circuit	Disconnect heating element plug from electronic control unit. Replace heating element
#42	Open window above cowl (window switch)	Close the window
#43	Over-voltage > 16.4V	Check battery voltage / voltage sources such as the charger
#44	Low voltage. Battery voltage is too low < 10.0 V	Charge battery. If necessary replace old battery
#45	No 230 V operating voltage	Restore 230V operating voltage
	Faulty 230V fuse	Replace 230V fuse
	Overheating protection has triggered	Please contact Truma Service
#112 #202 #121 #211	Gas cylinder or quick-acting valve in the gas supply line closed.	Check gas supply and open valves
	Gas pressure regulation system iced up	Use regulator heater (EisEx)
	Butane content in the gas cylinder too high	Use propane. Butane is unsuitable for heating, particularly at temperatures lower than 10°C.
#122 #212	Combustion air infeed or exhaust outlet is sealed	Inspect openings for obstructions (slush, ice, leaves, etc.) and remove any obstructions
	Gas pressure regulation system faulty	Inspect / replace gas pressure regulation system
	Electronic system faulty	Please contact Truma Service

TRUMA COMBI BOILER FAULTS

Error code	Cause	Remedy
#255	Heater has no 12 V power supply	Ensure that the 12V power supply is available
	No connection between heater and control panel	Make connection between heater and control panel
	Control panel cable faulty	Please contact the Truma Service
#417	Overvoltage > 16.4 V	Check battery voltage / voltage sources such as the charger
#302 #418	Low voltage. Battery voltage is too low < 10.0 V	Charge battery. If necessary replace old battery
#303 #411	Risk of low voltage. Battery voltage is too low < 10.4 V	Charge battery.
#401	Summer mode with empty water container	Switch heater off and allow to cool. Fill boiler with water
#402	Warm air temperature exceeded:	
	Not all warm air ducts are connected	Check whether the 4 warm air ducts are connected
	Warm air outlets blocked	Check the individual outlet openings
	Circulated air intake blocked	Remove the circulated air intake blockage
#407	No 230 V operating voltage	Restore 230 V operating voltage
	230 V fuse defective	Replace 230 V fuse (see Combi operating instructions)
#408	No gas supply in mix mode	Check gas supply. See fault #507 (electronic heating continues in Mix mode)
#412	Open window above cowl (window switch)	Close windows
#419	Overheating protection has triggered	Reset overheating protection (see Combi operating instructions) (gas heating continues in Mix mode)
#514	The 12v supply has been interrupted	Ensure the control panel of caravan / motorhome is switched on. Ensure charger is switched on and/or battery is connected.

Error code	Cause	Remedy
#507	Gas cylinder empty	Replacing a gas cylinder
#516 #517	Gas cylinder or quick acting valve in the gas supply line closed	Check gas supply and open valves, including crash sensor valve if en-route regulator is fitted.
	Gas pressure regulation system iced up	Use regulator heater (EisEx)
	Butane content in the gas cylinder too high	Use propane. Butane is unsuitable for heating, particularly at temperatures lower than 10°C
	Combustion air infeed or exhaust outlet is sealed	Inspect openings for obstructions (slush, ice, leaves, etc.) and remove any obstructions
	Gas pressure regulation system faulty	Inspect / replace gas pressure regulation system
#607	Max. number of fault resets reached	Wait 15 minutes and reset fault
#621	Room temperature sensor or cable faulty	Inspect the room temperature sensor cable, replace if faulty Check the resistance of the room temperature sensor. 15°C – 16.2kOhm / 20°C – 12.6 kOhm / 25°C – 10.0 kOhm Replace room temperature sensor if faulty
#624	FrostControl heating element has a short circuit	Disconnect heating element plug from electronic control unit. Replace heating element

9.3 Alde Compact 3020HE Boiler



The Alde Boiler can be used in the following ways:

- To provide combined room heating and water heating.
- Simultaneous heating of the room, and water contained within the appliance.
- To provide water heating only.
- Heating of the water within the appliance, without room heating.
- To provide room heating only, without water heating.
- If the water system has not been primed, meaning that there is no water within the appliance, it is still possible to use the Alde 3020HE to heat the room.

Alde 3020HE Control Panel and Appliance Instructions

Please read the user instructions before using the heating system. The instructions include warnings regarding the safe use of the system, and no liability whatsoever can be accepted for damage or injury resulting from failure to observe the instructions.

The heating system can be controlled by the Alde 3020 colour touch screen controller, or the Swift Command control panel, App., or remote control system.

For Swift Command functions please see the Swift Command literature and details within this handbook.

For use of the 3020 colour touch screen control panel, and the 3020HE system appliance, please read the information available at the following locations:

3020 Alde Heating System

http://www.alde.co.uk/downloads/alde_3020_user.pdf#page=17



Electrical Operation of Alde 3020HE Heating System

Before the heating system is used for heating using electrical (230v) energy, the 230v isolation button on the Sargent Power Supply Unit must be switched ON, as shown on page 120 (8.1)

Trouble-Shooting

The Alde control panel will display any error messages. See the Operating and Installation Instructions supplied separately.

The system is completely dead, the control panel is blank

- Check the 20 mm T3.15 Amp glass fuse in the boiler. This is located under the lid of the black plastic service hatch, in a green plastic fuse holder.
- Check the 12 V supply to the boiler, it should be above 12 V.
- Check the 12 V cable is plugged into the boiler. Check the cable is plugged into the Alde control panel.

The boiler will not ignite on gas

- Check the gas cylinder is full. Try a different gas cylinder, ensuring it is propane gas.
- The system may not need to use gas heating, if also using electric heating.
- The fluids in the boiler may already be at operating temperature.

The boiler will not heat on 230 V electric

- Check that the 230v isolation button on the Sargent Power Supply Unit is switched ON, as shown on page 120 (8.1)
- Check the 230 V supply to the vehicle.
- The fluids in the boiler may already be at operating temperature.

No hot water

- Check that hot water ignore is not activated on the Alde control panel.
- Check that constant pumping is not activated on the Alde control panel.
- Check for other conflicting settings on the Alde control panel.
- Check the freshwater supply and water pump.

No central heating

- Bleed the system of air.
- Check the fluid level in the expansion tank.
- Check that the circulation pump is responding.
- Check that hot water boost is not activated on the Alde control panel.
- Use gas and electric heating.
- Check that vents in the furniture are not obstructed.
- Check the condition of the heat transfer fluid.
- Most vehicles will reach a comfortable temperature within an hour, in non-extreme conditions.

If problems persist, please contact Alde, or your dealer or installer.

Warranty

Alde undertakes to rectify any manufacturing defect or early component failure through normal use that occurs within 12 months of the installation date.

If your Alde boiler develops a fault, your first action should be to contact your dealer or installer, as they will be familiar with your installation and vehicle, and how to make a claim under warranty.

Alde International (UK) Ltd Huxley Close Park Farm South Wellingborough Northamptonshire NN8 6AB

Tel. 01933 677765

www.alde.co.uk

ALDE FLOW

Alde Flow

Depending on specification, your tourer may be fitted with an Alde Flow continuous hot water system.

The Flow works in conjunction with the Alde 3020HE appliance, and can provide a continuous supply of heated water, at flow rates of up to 3.5 litres per minute, until the cold water supply is exhausted.

To use the Flow, ensure that the Flow is enabled in the 'installed accessories' section of the Alde control panel, and then select BOOST as the desired water temperature, on either the Alde controller or via Swift Command, depending on which method is being used to control the heating system. For optimum performance and continuous hot water, both gas and 3kw electric power should be used together.

Once BOOST is selected, the flow will operate for 30 minutes. After this time if further continuous flow of hot water is required, select BOOST again.

Further details of the Flow can be found at:

https://www.alde.co.uk/downloads/alde_3020-161_instruct.pdf

**Thermostatic Mixer Valve**

Depending on specification, your tourer may be fitted with a Thermostatic Mixer Valve. The valve is similar to those found in some domestic installations, and when fitted automatically mixes the supply of hot water from the heating appliance with additional cold water, in order to restrict the maximum water temperature available at the shower. (The thermostatic mixer does not affect hot water temperatures available at the kitchen tap or vanity tap)

The TMV is usually found in the lower vanity unit, or equivalent piece of furniture, adjacent to the shower.

Operation

Domestic hot water leaving the heating appliance, may be at temperatures of 70° or higher, and the TMV can limit the maximum hot water temperature available at the shower mixer to a much lower figure. The actual maximum temperature available at the shower mixer will vary, primarily, on the calibration of the valve. Typically the target temperature figure is around 38°

Adjustment to the target temperature range can be made, however it is recommended your dealer makes this adjustment for you.

Note: Check water temperature before entering the shower, and before each time that water is directed towards the body.

Alde Zonal Temperature Control

If equipped with Alde heating, your touring caravan may be fitted with a second thermostat, which can be used to control the heating system. In normal use (and on other ranges with Alde heating), the room temperature is measured by a sensor within the Alde touch screen control panel. With the Zonal control, it is possible to select room temperature measurement at the Alde control panel position, or, via the secondary temperature sensor fitted in the rear lounge or sleeping area.



Typical 2nd thermostat and switch installation

The 2nd sensor is a circular furniture mounted device, which has the word 'Alde' embossed on its surface. Next to the sensor, a Black round switch will feature '0' and '1' markings. With the switch in the '0' position, the room temperature will be measured at the Alde touch screen control panel (above the entrance door). With the switch in the '1' position, the room temperature will be measured at the 2nd temperature sensor position (typically in the bedroom area).

9.4 Dometic absorption refrigerator

Note: Before using the refrigerator for the first time carefully read the refrigerator manufacturer's operating instructions supplied with your caravan.

These instructions provide you with the necessary guidance for the proper use of your refrigerator. Observe in particular the safety instructions. Observation of the instructions and handling recommendations is important for dealing with the refrigerator safely and for protecting you from injury and the refrigerator from damage. You must understand what you have read before you carry out a task.

Keep these instructions in a safe place close to the refrigerator so they may be referred to at any time.

Your caravan is fitted with an absorption refrigerator from the Dometic range. The exact model fitted varies, and the model fitted can be confirmed by the data label fixed within the fridge compartment. This label will feature a model number in the format RM8406, RMS8556, RML10.4, RMD8556 or similar.

Using this model number, please read the user instructions for the refrigerator, which are available from the following location:

<http://td.dometicgroup.com/swift.php>



If you are unable to view the documents on line, please contact the supplier, your dealer or Swift for an electronic or paper copy.

9.5 Cooking Appliances

Note: Before you start using the Hob, Grill or Oven for the first time carefully read the cooking appliance manufacturer's operating instructions supplied with your caravan.

These instructions provide you with the necessary guidance for the proper use of your Hob, Grill or Oven. Observe in particular the safety instructions. Observation of the instructions and handling recommendations is important for dealing with the appliance safely and for protecting you from injury and the appliance from damage. You must understand what you have read before you carry out a task.

Keep these instructions in a safe place close to the appliance so they may be referred to at any time.

Your caravan will be fitted with one of the below Thetford ovens, depending on the range;

Basecamp (Plus Pack only) - Midi Prima

Sprite - Caprice

Challenger / Eccles / Elegance - K1520

For the latest version of the Thetford Manual, please visit www.thetford-europe.com



WARNING:

- Appliances and accessible parts become hot during use.
- Always use hand protection, e.g. oven gloves, when loading items into or removing them from the oven or grill.
- Avoid touching heating elements.
- Children less than 8 years of age shall be kept away unless continuously supervised.
- Children shall not play with the appliances.
- Unattended cooking on a hob with fat or oil can be dangerous and may result in fire.

- Never extinguish a fire with water, switch off the appliance and cover flame with lid or fire blanket.
- Danger of Fire: Do not store items on the cooking surface.

CAUTION:

- Do not use harsh abrasive cleaners or sharp metal scrapers to clean the hob glass lid or oven door glass since they can scratch the surface, which may result in shattering of the glass.
- Never use a steam cleaner to clean appliance.

WARNING: Before using the appliances for the first time, remove all accessories and packing in the grill and oven, including any surface protection film, i.e. plastic coating.

Gas Operation

Ensure the gas cylinder is turned on and the oven / hob gas isolation valve is open at the manifold. The burners on these appliances have fixed aeration and no adjustment is required. Depending on the gas being used, the burners should flame as follows:

Propane - The flames should burn quietly with a blue/green colour with no sign of yellow tips.

Butane - Normally on initial lighting, as small amount of yellow tipping will occur and then slightly increases as the burner heats up.

Note: For safe use of gas see advice in the services section.

WARNING: The grill must only be used with the door open.

Glass Lids

Depending on specification, your appliance may be fitted with a glass lid shut-off system, which cuts off the power to all hotplate burners (gas and electric) if the lid is closed.

- Ensure the glass lid is in the open and upright position before turning on the hotplate burners.

⚠️ WARNING:

- Glass lids may shatter when heated. Turn off the hotplate and allow it to cool before closing the glass lid
- Remove all spillage from the surface of the glass lid before opening.
- The glass lid on some models has the tendency to snap shut towards the end of lowering. This is caused by the travel lock action of the hinges as it is activated. Make sure all fingers are removed from appliance when closing the lid.

Do's and Don'ts

- Do** read the user instructions carefully before using the appliance for the first time.
- Do** allow the oven to heat before using for the first time, in order to expel any smells before the introduction of food.
- Do** clean the appliance regularly.
- Do** remove spills as soon as they occur.
- Do** always use oven gloves when removing food shelves and trays from the oven.
- Do** check that controls are in the off position.
- Don't** allow children near the cooker when in use. Turn pan handles away from the front so that they cannot be caught accidentally.
- Don't** allow fats or oils to build up in the oven tray or base.
- Don't** use abrasive cleaners or powders that will scratch the surfaces of the appliance.
- Don't** under any circumstances use the oven as a space heater.
- Don't** put heavy objects onto open grill and oven doors.

⚠️ WARNING: The use of the electric hotplate and gas hobs will generate heat. We recommend, to avoid excess build-up of heat around the cooker area, the window is left opened when cooking to allow for additional ventilation.

9.6 Microwave

(Where fitted)

ⓘ Note: Before using the Microwave for the first time carefully read the microwave appliance manufacturer's operating instructions supplied with your caravan.

Microwave oven general user instructions

To avoid possible exposure to excessive microwave energy please heed the following warnings:

⚠️ WARNING: Do not attempt to operate this oven with the door open since open door operation can result in harmful exposure to microwave energy. It is important not to defeat or tamper with the safety interlocks

⚠️ WARNING: Do not place any objects between the oven front face of the door or allow soil or cleaner residue to accumulate on sealing surfaces.

⚠️ WARNING: If the door or door seals are damaged, the oven must not be operated until it has been repaired by a competent person (1) door broken (2) hinges and latches (broken or loosened), (3) door seals and sealing surfaces.

⚠️ WARNING: It is hazardous for anyone other than a competent person to carry out a service or repair operation.

⚠️ WARNING: Liquids or other foods must not be heated in sealed containers since they are liable to explode

⚠️ WARNING: Only allow children to use the oven without supervision when adequate instruction has been given so that the child is able to use the oven in a safe way and understands the hazards of improper use.

Important safety guidance

⚠️ WARNING: Follow the important instructions below to ensure the safe use of the microwave and to prevent fire, burns, electric shock or damage to the appliance:

MICROVAVE SAFETY GUIDANCE

Important instructions

1. Do not use the oven for any reason other than food preparation, such as for drying clothes, paper, or any other non food items or for sterilizing purposes.
2. Do not use the oven when empty, this could damage the oven.
3. Do not use the oven cavity for any type of storage, such as papers, cookbook, cookware etc.
4. Do not operate the oven without the glass tray in place. Be sure it is sitting properly on the rotating base.
5. Make sure you remove caps or lids prior to cooking when you cook food sealed in bottles.
6. Do not put foreign material between the oven surface and door. It could result in excessive leakage of microwave energy.
7. Do not use recycled paper products for cooking. They may contain impurities which could cause sparks and/or fires when used during cooking.
8. Do not pop popcorn unless popped in a microwave approved popcorn popper or unless it's commercially packaged and recommended especially for microwave ovens. Microwave popped corn produces a lower yield than conventional popping; there will be a number of unpopped kernels. Do not use oil unless specified by the manufacturer.
9. Do not cook any food surrounded by a membrane, such as egg yolks, potatoes, chicken livers, etc., without first piercing them several times with a fork.
10. Do not pop popcorn longer than the manufacturer's directions. (Popping time is generally below 3 minutes). Longer cooking does not yield more popped corn it can cause scorching and fire. Also, the cooking tray can become too hot to handle or may break.
11. If smoke is observed, switch off or unplug the appliance and keep the door closed in order to stifle any flames.
12. When heating food in plastic or paper containers, keep an eye on the oven due to the possibility of ignition.
13. The contents of feeding bottles and baby food jars shall be stirred or shaken and the temperature checked before consumption, in order to avoid burns.
14. Always test the temperature of food or drink which has been heated in a microwave oven before you give it to somebody, especially to children or elderly people. This is important because things which have been heated in a microwave oven carry on getting hotter even though the microwave oven cooking has stopped.
15. Eggs in their shell and whole hard-boiled eggs should not be heated in microwave ovens since they may explode, even after microwave heating has ended.
16. Keep the waveguide cover clean at all times. Wipe the oven interior with a soft damp cloth after each use. If you leave grease or fat anywhere in the cavity it may overheat, smoke or even catch fire when next using the oven.
17. Never heat oil or fat for deep frying as you cannot control the temperature and doing so may lead to overheating and fire.
18. Liquids, such as water, coffee, or tea are able to be overheated beyond the boiling point without appearing to be boiling due to surface tension of the liquid. Visible bubbling or boiling when the container is removed from the microwave oven is not always present. This could result in very hot liquid suddenly boiling over when a spoon or other utensil is inserted into the liquid.

To reduce the risk of injury to persons:

- a. Do not overheat the liquid.
- b. Stir the liquid both before and halfway through heating it.
- c. Do not use straight-sided containers with narrow necks.
- d. After heating, allow the container to stand in the microwave oven for a short time before removing the container
- e. Use extreme care when inserting a spoon or other utensil into the container.

Care of the microwave

1. Turn the oven off before cleaning
2. Keep the inside of the oven clean. When food spatters or spilled liquids adhere to oven walls, wipe with a damp cloth. Mild detergent may be used if the oven gets very dirty. The use of harsh detergent or abrasives is not recommended.
3. The outside oven surface should be cleaned with soap and water, rinsed and dried with a soft cloth. To prevent damage to the operating parts inside the oven, water should not be allowed to seep into the ventilation openings.
4. If the central panel becomes wet, clean with a soft dry cloth. Do not use harsh detergents or abrasives on Control Panel.
5. If steam accumulates inside or around the outside of the oven door, wipe with a soft cloth. This may occur when the microwave oven is operated under high humidity conditions and in no way indicates malfunction of the unit.
6. It is occasionally necessary to remove the glass tray for cleaning. Wash the tray in warm sudsy water or in a dishwasher.
7. The roller guide and oven cavity floor should be cleaned regular/y to avoid excessive noise. Simply wipe the bottom surface of the oven with mild detergent water or window cleaner and dry. The roller guide may be washed in mild sudsy water.
8. The oven should be cleaned regularly and any food deposits removed;
9. Failure to maintain the oven in a clean condition could lead to deterioration of the surface that could adversely affect the life of the appliance and possibly result in a hazardous situation.

9.7 Toilet

Thetford Toilet

Note: Please read the user manual supplied with the toilet before using and the toilet.

All Swift caravans are fitted with a Thetford C260 toilet except for the Basecamp caravan which is fitted with a Thetford C402 toilet.

The user manuals can also be read on line:

C260 Toilet

<https://www.dropbox.com/s/uwbfrtwcium021z/C260%20UM%20EN.pdf?dl=1>



C402 Toilet

<https://thetford-europe.com/api/v1/DocumentTranslation/1228/ContentDownload>



TRUMA / WHALE BBQ POINT
/ BBQ OUTLET SOCKET

9.8 External BBQ point

(Where fitted)



Models equipped with an external barbeque point can be used to power any gas appliance suitable for the gas used in the caravan, at the working pressure shown on the label in the barbeque outlet box. Please note when using the outlet that the fitted regulator will allow a maximum of 1.5kg per hour of gas to be taken from the gas bottle. Therefore the consumption of gas from both the appliances within the caravan and the appliance connected to the barbeque point cannot exceed a total of 1.5kg per hour at any one time. If you are in any doubt please consult your dealer for advice.

Truma BBQ Point

(Where fitted)



Lift the flap to gain access to the BBQ coupling point

Whale BBQ Point

(Where fitted)



Slide the cover up as shown in the diagrams below to gain access to the BBQ point

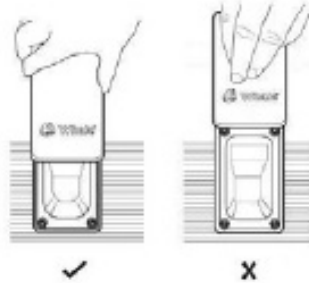

BBQ Outlet Socket

The external BBQ outlet socket is designed to supply an exterior BBQ using your LPG (Propane or Butane) recreational vehicle on board gas supply.

This tap is designed solely for gas supply from the vehicle to an exterior BBQ.



⚠ WARNING: The caravan BBQ point should only be used as an outlet point for gas, never connect a gas bottle direct to the outlet.

The valve is designed in accordance with BS EN 1949-2011 and cannot be operated unless the hose fitting, supplied with the caravan, is in place.

Gas fitting

⚠ WARNING: Fit flexible gas hose from BBQ to the gas fitting before inserting it into the BBQ point.

The gas tap has an integrated non-return valve therefore gas cannot be supplied to the vehicle.

Connecting & Disconnecting BBQ

Open the cover flap and remove the protection seal. With the supplied connector fitted to BBQ hose, insert the connector into outlet as shown below:



Rotate valve handle to the ON position as shown in the image below to start the gas supply to your exterior BBQ. Please note valve handle will not open and gas supply won't flow when hose is not connected. This is an additional safety feature of the Whale External BBQ Outlet Socket.



To disconnect, first turn the valve handle back to the OFF position as shown above, then slide back the collar to release the connector and remove as shown in the image below. Re-fit the protection seal and ensure socket lid is closed when not in use.

⚠ WARNING: Care should be taken when using the external barbeque point. Never barbeque next to an awning or tent.

9.9 External Shower point

(When fitted)

The external shower point, uses a separate shower head and hose assembly supplied with the caravan if a shower point is fitted.

Truma Shower Point

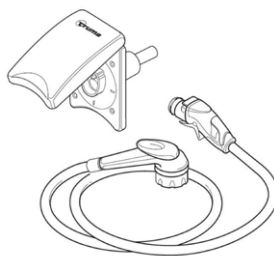

To connect the shower, simply align the plug with the socket and push into position. To remove, pull the lower trigger and pull the plug from the socket.

Whale Shower Point

(Basecamp when fitted)

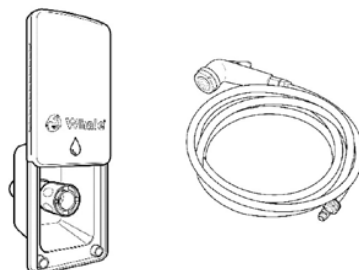

EXTERNAL SHOWER POINT

Assemble hose and fittings as shown in the image below

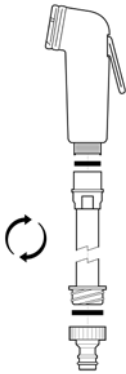

Slide the cover up as shown in the diagrams below to gain access to the shower point

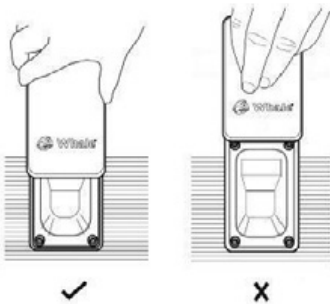

Push back the collar and remove end stop as shown in the image below



Align the shower hose connector with the socket and push into position as shown in the images below

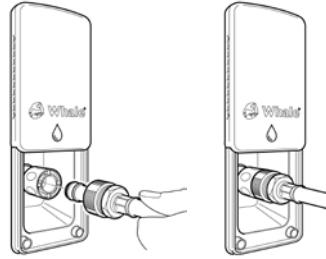

To remove the shower, push back the collar on the shower outlet fitting, then pull the shower hose connection away from the socket. Refit the end stop.

CAUTION: This socket is for water out use only. To avoid risk of damage to the water system, do not use to supply water to the vehicle.

CAUTION: During periods of cold weather, ensure vehicle is fully drained of water to avoid damage to socket and fittings.

9.10 Status directional TV antenna

(When fitted)

Your caravan is fitted with a Status 570 TV aerial. Please read the user instructions for the TV aerial, which are available from the following location:

<http://www.visionplus.co.uk/assets/pdfs/2016/570%20RETAIL%20Instructions%20A3%20Lilac%2018-08-15.pdf>



If you are unable to view the documents on line, please contact the supplier, your dealer or Swift for an electronic or paper copy.

9.11 TV inlet battery box

(When fitted)

Models equipped with TV points in the battery box have the facility to take an external signal and supply that signal to TV points within the caravan.

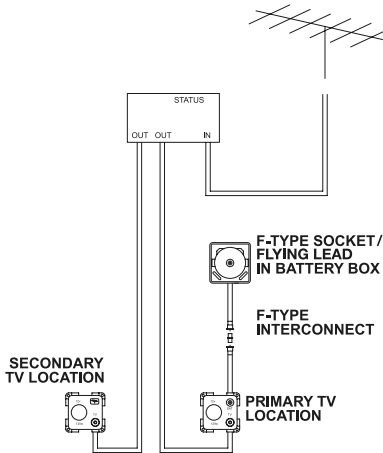

Caravans equipped in this way feature a direct link from the connection point in the battery box, to an auxiliary connection point at the primary TV position within the caravan. The direct link can be used to:

1. Supply an external signal (caravan site TV feed) to the primary TV position
 - a. Connect the socket in the battery box (on flying lead depending on model), with a suitable lead, to the appropriate socket on the caravan site supply post. As the connector in the battery box is a screw on 'F-type' connector, an adaptor to convert this to a 'push-on' co-ax connector, which may be required, has been supplied with your caravan.
 - b. Locate the primary TV position within the caravan. At the 12V, TV and SAT socket, connect your TV to the output from the socket marked SAT with a suitable lead.
2. Connect an external satellite dish to a decoder within the caravan. (The direct link uses F-type interconnects throughout to allow the decoder and dish to communicate correctly)
 - a. Connect the dish to the socket (or flying lead) in the battery box with a suitable lead. The F-type to co-ax adaptor should not be used.
 - b. Connect the dish input connection on the decoder to the 'SAT' socket on the 12V, TV and SAT socket located in the primary TV location.
3. Supply a signal from within the caravan to the exterior of the caravan
 - a. Connect the output from your VCR, DVD player or other device to the SAT connection on the 12V, TV and SAT socket at the primary TV position.
 - b. Connect your receiving device (TV or similar) to the socket in the battery box with a suitable lead.

As can be seen from the simplified schematic, when multiple TV locations are present in a van, all of these receive signals from the TV aerial connection box. Using adaptors and link cables which are readily available, it may be possible to re-direct a signal from the 'SAT' connection at the primary TV location, up to the aerial connection box to be then distributed to other TV positions within the caravan. Please remember that as the number of connections increases the quality of the signal reduces.

Please note that some installers of motor movers will locate the isolation switch for the mover in the position used by the external TV point in the battery box (model specific), resulting in the loss of this functionality.

ENTERTAINMENT EQUIPMENT

9.12 Entertainment equipment

Audio-visual equipment may have been fitted by your dealer, or supplied with the caravan, depending on the specification of the caravan. Although not specific, below are details of the types of equipment which would be fitted as appropriate to the specification of the caravan:

FM/DAB/AUX-in Receiver

The receiver is operated using the control panel above the entrance door. For details of how to operate the receiver, see the Swift Command instructions elsewhere in this handbook.

3.5mm Audio Jack (when fitted)



To use the connection on the binnacle or front TV unit (layout specific), plug the 3.5mm lead in the locker near the FM/DAB/Aux-in receiver into the dedicated socket on that device. At the binnacle or TV unit, locate the 3.5mm jack socket. Use an appropriate lead (not supplied) to connect the headphone socket on your device, to the 3.5mm socket on the binnacle or TV unit. Use the control panel above the door to select Aux-in as the audio source, and then adjust the volume levels both on your device, and on the receiver, to find the appropriate sound level.

Caravans with external entertainment point (when fitted)



An external service door positioned on the door side of the caravan houses the connection points and an extended vesa bracket to mount a TV for viewing inside the awning. This comprises 230v & 12v sockets, aerial points and the TV bracket.

The maximum weight of the TV should not exceed 4.5kg, this is intended for use in conjunction with an awning to provide weather protection for the TV and its connections.

⚠️ WARNING: A TV should never be mounted and connected to the mains supply outside an awning

It is also important to ensure cables and equipment are maintained in good condition and simple checks are made every time you use it ensuring cables are retained to prevent the potential for trip hazards.

Caravan WiFi (when fitted)

On some models only, a 3G/4G antenna is pre-fitted, which is connected to a MiFi (My Wifi) device. This system connects to the cellular network, and provides a Wifi connection inside your tourer for up to 10 devices to connect to.

Please check with your dealer whether the MiFi device is fully installed in your tourer, and whether the SIM card supplied with the device has been pre-installed. The position within the tourer is layout specific.



Once the SIM card is installed and components are connected, basic operation is as follows:

- Turn on the power to the device, using the switch on the base of the unit, at the left hand side. A Red LED will illuminate, and a charging / battery symbol will appear in the display on the front of the unit.
- Press the power button on the front of the unit. The display will change while the device starts, and once the unit is ready, a network name and passkey will appear on that display.
- Search for Wifi on your mobile phone / tablet / laptop, looking for the network name as displayed on the device. Connect, and when prompted for the passkey/password, use the code as displayed on the screen.

Complete user instructions, including how to fit the SIM card and mount and connect the MIFI device if still required, can be located at the address below. Please read these instructions before using the system.

www.motorhomewifi.com/swift/



If you are unable to view the documents on line, please contact the supplier, your dealer or Swift for an electronic or paper copy.

9.13 Bedding Configurations

For details of cushion positions on individual models please see the technical handbook

Front Double bed assembly

Elegance Grande, Challenger X, Eccles X and Sprite Super

1. Remove the cushions from the front side seats.
2. Lift up seat base and unfold support leg
3. Pull extendable slatted seat base to the centre of the van
4. Repeat steps 2 & 3 for the other side.
5. Position the seat backs and infill cushions on the pull out section to make up bed. Fig. B

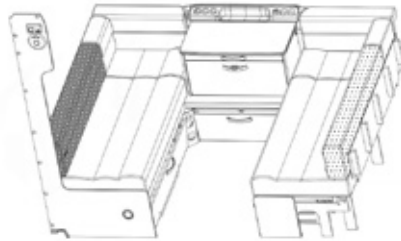

Fig. A

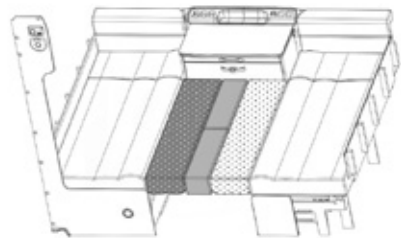

Fig. B

BEDDING CONFIGURATIONS

Front Double Bed Assembly

Sprite, Challenger, Eccles and Elegance

1. Grip front of slatted bed pull out and walk backwards until pull out fully extended.
2. Locate front rail of pull out behind bump stops on seat rails.
3. Position the seat backs on the pull out section to make up bed. Fig. D

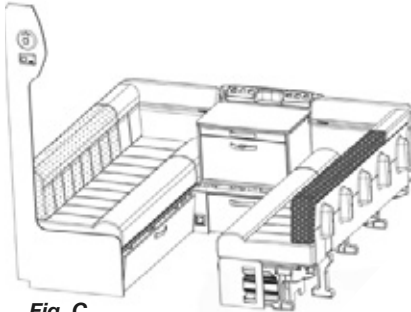

Fig. C

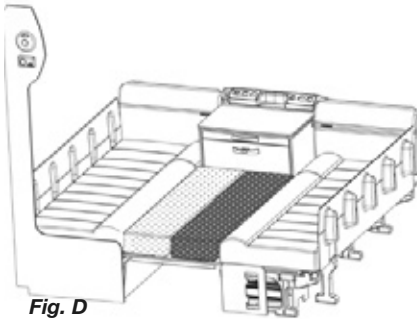

Fig. D

Front L Double Bed Assembly

Quattro EW

1. Lift the table off the support leg and remove leg from the base and put it to one side
2. Position the table between the seats on the support rails at the front of the seat bases.
3. Position the seat backs and infill cushions on the lowered table

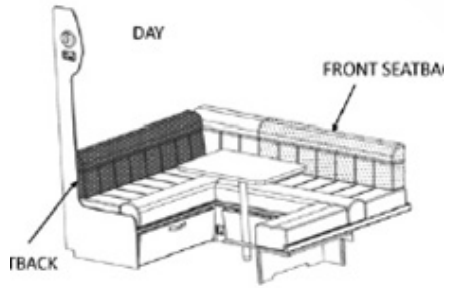

Fig. E

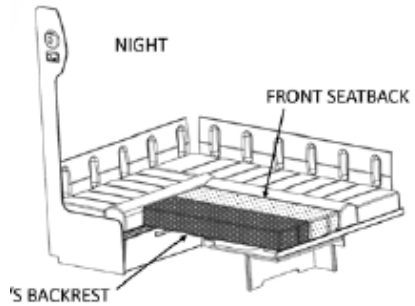

Fig. F

Front L Double Bed Assembly

Elegance Grande 850, Challenger X 850 and Eccles X 850

1. Remove the cushions from the front side seats.
2. Lift up seat base and unfold the support leg attached to the pull out section of seat base. Fig G
3. Extend the pull out section of the seat base towards the rear of the van.
4. Fold the top section of the seat base over and lower onto the pull out section.
5. Position the front seat base on the fold out section and fill the gap at the front with the seat back cushions to make up bed. Fig. H

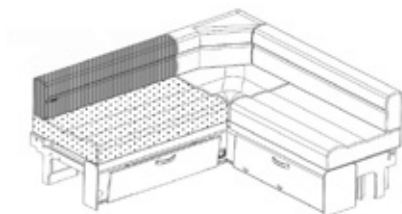

Fig. G

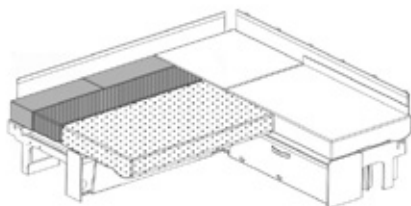

Fig. H

Basecamp

Front Seats/Bed

When front seats are not required the seat bases can be folded up clipped against the side walls. The support legs can be folded down to give more space.

When using them as seats the inner support leg should be unfolded as this supports both the main seat and pull out in the closed position.

To make up into a bed:

1. Remove the cushions from the front side seats.
2. Lift up seat base and unfold the outer support leg
3. Pull extendable slatted seat base to the centre of the van.
4. Repeat steps 2 & 3 for the other side.
5. Position the seat backs on the pull out section to make up bed. Fig. J



Fig. I



Fig. J

BEDDING CONFIGURATIONS

Mid or Rear Day Seat with Hook on Table

1. Lift the front edge of the table and unhook from the side rail.
2. Fold the table leg under the table.
3. Position the table between the seats on the support rails at the front of the seat bases.
4. Position the seat backs on the lowered table to make up the bed.

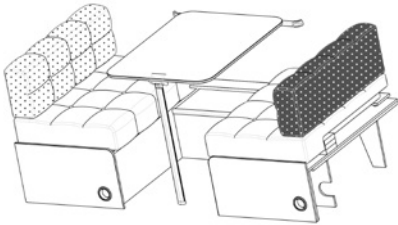

Fig. K

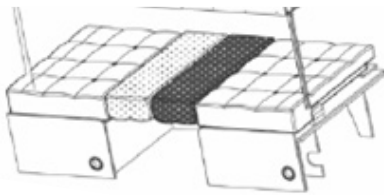

Fig. L

Mid or Rear Day Seat with Telescopic Table Leg

1. Release the telescopic table leg mechanism and lower the table until it matches the seat base height.
2. Re-lock the mechanism to hold the table in the lowered position.
3. Position the table between the seats.
4. Pull out bed supports from the ends of the day seats if fitted.
5. Position the seat backs and infill cushions on the lowered table and pull outs to make up the bed.

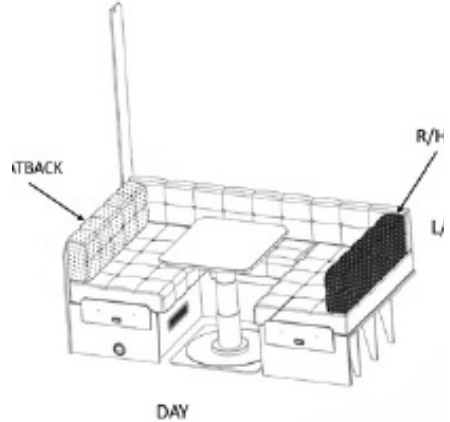

Fig. M

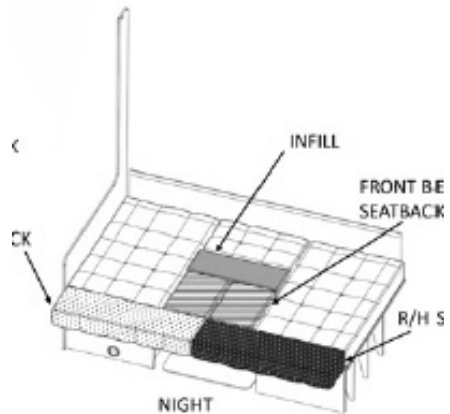
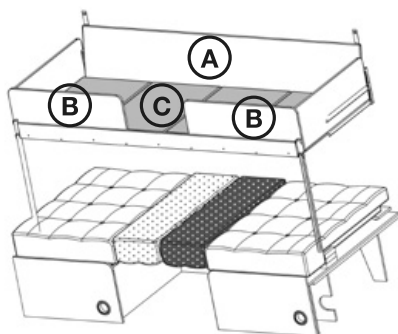

Fig. N

Lift-up bunks

1. Grasp the bunk and pull carefully upwards and towards you. Allow the upper edge to move first and then rotate the bottom edge forward and upwards
2. The bunk is designed to automatically move into the correct position.
3. Where a bed board is fitted, unfold and make sure it is secured by press studs when lifted into position. (The bed board is required to protect both the occupant and the window from damage during use of the bunk.) (A)
4. Locate safety boards. (B)
5. Arrange seat cushions as appropriate. (Fig. O)

**Fig. O**

Note: Bunks are designed to carry a child to a maximum of 70kg (11 stone)

WARNING: use the upper bunks for sleeping only, with the provided protection against fall out in position.

WARNING: Care shall be taken against the risk of fall out when the upper bunks are in use by children especially under 6 years of age, these bunks are not suitable for use by infants without supervision.

9.14 Exterior door

CAUTION: To prevent damage to the door lock always ensure that the internal handle is in the central neutral position when closing the door. Never attempt to close the door with the internal door handle in the locked or partially locked position.

Hartal Door operation Basecamp, Sprite, Challenger & Eccles

The door is locked and unlocked from the outside with the use of the exterior door key.



To open the door pull the side of the door handle.



To open the door from the inside push down on the interior door handle. To deadlock the door from the inside, push the interior door handle upwards.

EXTERIOR DOOR

Domtic Seitz Door operation Elegance

The door is locked and unlocked from the outside with the use of the exterior door key. To open the door pull the door handle.

Exterior Door Key

CAUTION: should be taken not to leave the exterior door key in the door when unlocking the door. The key may result in damage in the vehicle side if the door is released with the key still in the lock

Exterior Door Retainer

CAUTION: The door retainer is designed to hold the door in normal conditions. In gusty or windy conditions we recommend the door is closed to prevent it releasing and slamming shut.

**Door Screen**

The door fly screen is tracked top and bottom and operation must be by the centre of the handle to aide a smooth operation.

The door fly screen operates independently of the door by sliding across the door threshold.

WARNING: When opening or releasing the door screen, care must be taken to avoid trapping fingers.

Door Blind

(When fitted)

The door blind (when fitted) slides vertically within the door cassette.

**9.15 Windows**

To open all window types push the central button with your thumbs and turn the internal handles through 90 degrees and push open the window.

Ratchet Stays:

The windows lock in the open position at three pre-set positions located within the stays. To operate, push open the window until you hear an audible click and then slowly release the pressure to lock the window in the first open position. Push open again to find the next locking position. To close, fully open the window which will disengage the locks and allow the window to close slowly and lock off the handles by turning back through 90 degrees.

Windows / Roller Blind Advice

Note: In case of prolonged exposure to the sun roller blinds should not be completely closed as this could cause excessive heat concentration at the top of the window, due to characteristics of the glazing material the

windows could be adversely affected.

Roller blinds that shade from the bottom upwards it is necessary to leave a gap of a few centimetres open at the top, this way the heat between window and blind can escape. A fly screen does not cause an obstruction.

Roller blinds that shade from the top downwards must be kept completely open, or be opened regularly to allow the heat to escape.

Keeping the windows in ventilation position allows heat to escape.

CAUTION: Never fully close a roller blind system when storing the vehicle or when not in use for longer periods

9.16 Roof lights

When opening the roof lights, care must be taken to release the locking mechanism as the unit is raised.

The roof lights provide high level fixed ventilation for the caravan. For your own safety these must never be blocked off.

WARNING: When closed there is a free airflow throughout the rooflight, which must be kept free at all times.

CAUTION: Ensure that all windows and roof lights are closed and the blinds open when the vehicle travels on the road.

WARNING: Never stand on the dome of the rooflight

MPK Rooflight

(when fitted)

Instruction for use

The rooflight can be opened fully, or in four different directions, so that the dome can be angled against driving weather conditions. The handle profiles of both roller blinds (flynet and roller blind) click into space at the edge of the frame and can be opened by pulling the handle (arrow on the handle profile).

ROOF LIGHTS



With both handle profiles clipped together they can be moved to any position. To separate, fully open the flynet and squeeze together the catches on the central lock and allow flynet to recoil.

Care instructions:

The rooflight should only be washed by hand, using a sponge with plenty of clean water to avoid scratching. Caustic detergents and solvents may attack the plastic and make it brittle or disintegrate.

For easier cleaning of the dome it can be removed from the frame by releasing the four screws holding the handle arms. Do this from the inside of the van.

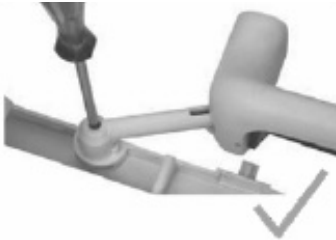

Lift the dome clear of the roof and rotate so that it can be lowered into the van across the diagonal of the aperture.

Make sure that only the original screws are used when replacing the dome and that they enter the thread in the plastic correctly. Do not over-tighten.

Never remove the screws holding the dome and the handles together. These are secured by a torque screwdriver and should only be handled by an approved dealer.

Heki Roof Lights
Micro-, Mini- and Midi-Heki
 (When fitted)



Fig. A

To open depress the button.



Fig. B

Pull the bar down and forwards.

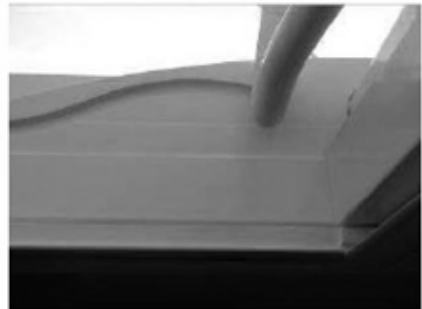
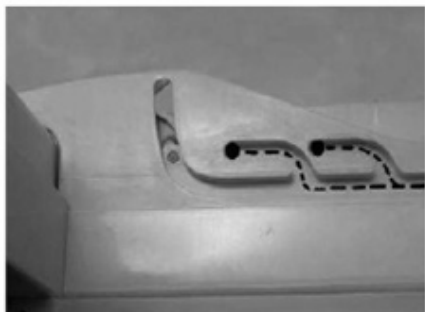

Fig. C

Pull the bar the full length of the track to fully open the roof light.



By pushing the bar into the marked rest position, (Fig D) two (one on Micro) extra opening angles, apart from the one in which the dome is fully opened, can be chosen.

Electric Heki

(when fitted)

Opening the dome:

Push the button until the desired position is reached or the electrical motor switches off.

Closing the dome:

Push the button until the electrical motor switches itself off. Check the dome is securely locked by gently trying to lift it by hand.



Opening/closing the blind and fly net:

Pull the end rod from the recessed part and push into desired position. Both the blind and fly net are adjustable in any position and can be used independently.

Care & Safety instructions

Repairs should only be carried out by trained personnel

Do not step on the acrylic dome

Before towing the caravan close all the rooflights and ensure that they are locked and open the blinds.

Do not leave the vehicle unattended with the rooflights open (danger of burglary)

Do not open the dome in strong wind or rain

Before opening the dome, remove snow, ice, dirt, etc. from the acrylic dome

Do not use caustic detergents (danger of tension cracks in the acrylic dome)

To ensure the required ventilation keep the space between roof and glazing dome free of dirt and snow.

The acrylic dome can be cleaned with mild soap solution or with the Seitz acrylic cleaner
Spots and light scratches on the acrylic dome can be removed with the Seitz Acrylic Polish and the Seitz Special Polishing cloth:

Where rubber seals are fitted use talcum powder regularly (4 times yearly) to prevent the rubber seals sticking.

Clean the blinds with water and mild soap suds only.

OMNI-VENT

Omni-vent

(when fitted)

To open the roof cover turn the knob in the Omni-vent surround clockwise. Turn anti-clockwise to lower the cover.

⚠ CAUTION; The lid must always be closed when travelling.

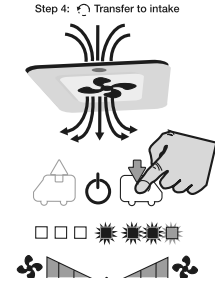
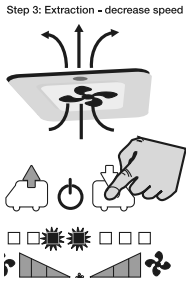
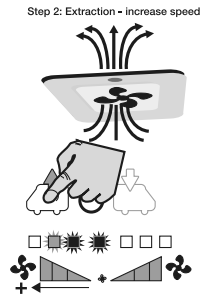
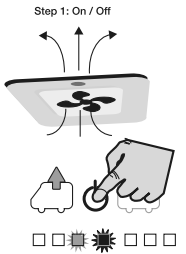

Fan operation

The fan is turned on by touching the on/off soft touch button S2. The middle LED light lights up and the ventilator starts in comfort mode, this is the lowest speed (extract). See fig 18.

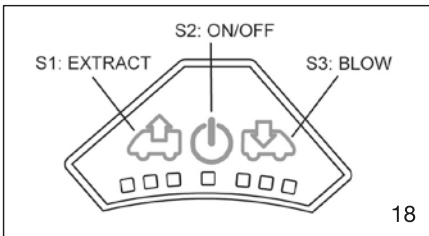

18

By pushing on the switch S1 (extract) or S3 (intake), the airflow can be adjusted in 6 steps. See table below.

PUSH BUTTONS	LIGHTS	SPEED	Amperes	Watt
	■ ■ ■ ■ ■	0	0,2 mA	2,4 mW
1x	■ ■ ■ ■ ■	1 st	0,17 A	2 W
1x + 1x	■ ■ ■ ■ ■	2 nd	0,48 A	5 W
1x + 2x	■ ■ ■ ■ ■	3 rd	0,90 A	11 W
1x + 3x	■ ■ ■ ■ ■	4 th	1,55 A	30 W
1x + 4x	■ ■ ■ ■ ■	5 th	3,22 A	40 W
1x + 5x	■ ■ ■ ■ ■	6 th	7,20 A	85 W
1x + 5x + 1x	■ ■ ■ ■ ■	5 th		
1x + 5x + 2x	■ ■ ■ ■ ■	4 th		
*** **				
1x	■ ■ ■ ■ ■	0	0,2 mA	2,4 mW

PUSH BUTTONS	LIGHTS	SPEED	Amperes	Watt
	■ ■ ■ ■ ■	0	0,2 mA	2,4 mW
1x	■ ■ ■ ■ ■	1 st	0,17 A	2 W
1x + 1x	■ ■ ■ ■ ■	0	15 mA	0,2 W
1x + 2x	■ ■ ■ ■ ■	1 st	0,17 A	2 W
1x + 3x	■ ■ ■ ■ ■	2 nd	0,48 A	5 W
1x + 4x	■ ■ ■ ■ ■	3 rd	0,90 A	11 W
*** **				

*MIN = 3,7 m3/min (2 W - 0,17 A)

*MAX = 24 m3/min (86 W - 7,20 A)

In order to save the battery, the speed drops from position 6 to the lowest position after one hour of use.

- It is possible to allow the ventilator to work for 5 minutes on the highest speed (boost). To do this push for 3 seconds on the button S1 (extraction) or S2 (intake). After 5 minutes the ventilator returns to its previous speed setting. See table below.

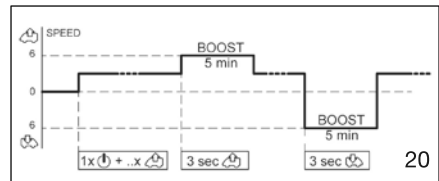

For reasons of security, the ventilator, the ventilator stops when the tension is too high (19,5 V) or too low (11,1 V) or when the fan is blocked. For trouble shooting see fig 21.

Maintenance

The ventilator grid can be removed for cleaning. Also the mosquito screen can be taken out for cleaning.

Dometic CK500 Cooker Hood



The Dometic CK500 cooker hood is fitted to some models of touring caravan, and features a filter that is detachable and washable, LED lighting and two 12v fans.

For details of the operation and maintenance of the cooker hood, please read the information at the following locations:

<https://www.dometic.com/en-gb/uk/products/food-and-beverage/mobile-kitchen/extractor-hoods/dometic-ck-500- -153275>



9.17 Tables

Table storage

To avoid damage care must be taken when removing tables from their stored position.

Where two tables are stored together in a low level storage area care should be taken to remove the table positioned opposite the hinged edge first.

Tables stored in the table storage compartment must be securely clipped into place whilst in transit.

Free standing tables

⚠️ WARNING: When erecting the free standing table, be careful to avoid trapping fingers.

Top chest Table

Slide the top of the chest of drawers forward to form a convenient table. Lift the rear portion to slide the top away. (Fig. A)



Telescopic table operating instructions (where fitted)

To adjust the height

The table has two positions. The higher position for dining and the lower position for sleeping.



Turn the lever (below the table top) anticlockwise in order to lock the table at its preferred height. If you wish to lower the table, pull the lever 180° clockwise. You can then push the table down as the "brake" has been released. As soon as the table is in the lowest position, turn the lever 180° up again (anticlockwise) in order to fix it in its lowest position.

NOTE: When erecting the free standing table, be careful to avoid trapping fingers.

To place the table in its upper position, turn the lever 180° once more and it will move upwards. To fix it in its upper position turn the lever again 180° to lock it in place.



9.18 Awnings

Fire precautions

⚠️ WARNING: Keep any naked flames away from the awning fabric. Do not place hot appliances near the walls, roof or curtains. Always observe the safety instructions for these appliances. Never allow children to play near hot appliances. Keep passage ways clear. Make sure you know the fire precaution arrangements on the site. Make sure ventilation openings are open all the time to avoid suffocation.

Ventilation

⚠️ WARNING: Awnings should be kept ventilated when discharging products of combustion exhaust in to them.

⚠️ WARNING: Make sure ventilation openings are open all the time to avoid suffocation.

All awnings are prone to condensation when air on the inside is warmer than outside. Increase ventilation by leaving doors open when possible and opening vents.

Care points

Whilst all the seams on your awning are taped to prevent these seams leaking, due to the way the awning is affixed to the caravan in some circumstances you may experience some ingress of water in these attachment areas.

🛑 CAUTION: Awnings should be taken down in strong winds to protect body panels from cosmetic damage.

Cleaning and drying

Whenever possible pack the awning when it is dry. If wet, dry thoroughly at first opportunity if the awning is to be stored. Storing the awning when wet will cause mould to grow, which will degrade the fabric.



Basecamp

A Vango Air Awning has been specifically designed to fit the rear of your caravan. This option is available through the dealer network and should you wish to purchase then please contact your supplying dealer.

Vango Assembly

Before pitching your awning study the photograph on the awning bag, this illustrates what the awning should look like when assembled. Check that all the components are correct and undamaged. Review the assembly instructions and familiarise yourself with the procedures before pitching your awning for the first time.

Vango Warranty

The awning is supplied with a standard 2 year warranty which can be extended by a further year if the awning is then registered with Vango.

Vango Contact:

Vango can be contacted by telephone on

0844 770 7058 or alternatively by logging on to the Vango web site at <https://www.vango.co.uk>

Elegance, Challenger, Challenger X, Eccles, Eccles X, Sprite

Fixing of awnings

In order to avoid puncturing the outer skin of the caravan wall, it is recommended that awning poles are fixed to your caravan using load spreading eyelet pads or rubber sucker pads.

📌 Note: Attaching awning brackets and associated fixings to your caravan by using mechanical methods which pierce the outer skin of the caravan wall can allow water ingress which will invalidate the product warranty.

TV BRACKETS / CYCLE RACKS

⚠ CAUTION: Care must be taken when using an awning as poles and suckers can cause damage to exterior side panels.

Awning Sizes

Due to the various awning types and sizes the awning sizes provided in the Service and Warranty Handbook are for guidance only.

Full details and sizes of awnings (A-A dimensions) for your caravan can be found in your Technical Handbook.

ⓘ Note: Specific awning sizes must be confirmed with the dealer or awning manufacturer prior to purchase.

9.19 TV brackets

(when fitted)

ⓘ Note: In some models a bulkhead mounted bracket is supplied to mount a TV on. Whilst the bracket has a secure travel lock, it is good practise to un-clip the TV from the bracket and store securely for transit.

9.20 Cycle racks

Basecamp

The basecamp is not suitable for an exterior cycle rack. There is space inside the van for cycles when the front beds are folded up.

Elegance, Challenger, Eccles, Sprite



ⓘ Note: Elegance Grande 635 is not suitable for cycle racks due to escape window.

The Swift Group allows the fitment of a two cycle rack carrier and we have made provision for this with two pre-positioned mounting rails fitted to the rear of your caravan. These are spaced at either 800mm or 850mm apart. Below are the racks which can be purchased from Thule, which are compatible with the pre-fitted rails.

The fitment of a cycle rack may obstruct the rear view camera fitted to some caravans.

The Swift Group only recommends a Thule cycle carrier which will conveniently clip in to the pre-installed mounting rail.

Thule Bike carriers

Thule Bike carrier type	Thule Excellent standard version	Thule Elite G2 standard version	Thule Sport G2 standard version
			
Thule reference	309821	306560	307126
Capacity (# bikes)	2+1+1	2+1+1	2 + 1
Max load to be placed on the rack (kg)	50	50	50
Max individual bike weight (kg)	30	30	19
800mm Fixing rail spacing	Yes	Yes	Yes
850mm Fixing rail spacing	Yes	Yes	Yes

⚠ CAUTION: The caravan rear is designed to carry a maximum load of 50 kg. The maximum weight of the rack and any cycles carried must not exceed 50 kg.

ⓘ Note: Dependent on model, visibility through the rear camera may be reduced when bicycles are carried on the optional bike carrier.

ⓘ Note: Care should be taken to compensate for the extra load on the rear of the caravan to ensure an adequate nose weight. Payload within the van may have to be moved forward to achieve this

9.21 Digital reversing rear view camera

(if fitted)

The rear view camera is a driving aid, it is not a supplement too, nor a replacement for safe driving and good all-round observation. The driver is responsible for the safe manoeuvring and detection of pedestrians, objects and obstacles particularly when reversing. The rear view camera image may be observed at all times when using the camera. When reversing a responsible adult should assist in guiding the driver into confined spaces particularly when obstacles or pedestrians may be present or when visibility or lighting levels are reduced. The mandatory required rear view door mirrors must be maintained and used as the primary rear visibility aid.

The camera image quality can be affected by dirt, road spray, rain droplets, snow, ice and as such the camera lens will require regular inspection and cleaning. Image quality will be reduced at night time or by bright lights shone in low level lighting conditions.

The Caravan Reversing Camera Kit features an LCD monitor for use as a reversing / rear view aid, and also includes satellite navigation software.



⚠ WARNING: This reversing / rear view camera system is provided as an aid only. It should not be relied upon as the sole indication of your vehicle position or the position of other vehicles or any obstacles. The supplier, manufacturer or supplying dealer accepts no responsibility for damage or injury to property or persons following the use or misuse of this equipment.

System Operation

The monitor and camera system is provided as an aid when reversing your caravan and can also be used to provide an additional view from the rear of the caravan whilst driving.

It should not be relied upon as the sole indication of your vehicle position or the position of other vehicles or any obstacles.

When reversing or manoeuvring please ensure the area around your caravan is clear from obstructions, and do not wholly rely on the camera view, use your mirrors and seek assistance as required.

Connecting the Car

Before you can use the monitor with the camera you need to connect your caravan to the car with the 13 pin towing connector.

When the car engine is started the rear camera will receive power and switch on automatically.

Installing the Monitor in the towcar

The monitor has various features you should be familiar with for correct operation.

Firstly attach the mount to the rear of the monitor and connect the car power cable. The monitor mounting plate clips to the rear of the monitor. The windscreen mounting then clips onto the mounting plate. The power cable plugs into the mini-USB socket on the side of the monitor with the other end plugging into the car power socket.

SYSTEM OPERATION

The monitor has an internal rechargeable battery which will last for around 1 hour when used without the power cable. This battery is charged when the power cable is connected. Charging is indicated by a red LED on the side of the monitor.

Now attach the monitor mount to the windscreen using the suction mounting.

- Do not position the monitor in a place that will block the drivers' view of the road.
- Do not block air bags or other dashboard features.
- Safely position the power cable to prevent entanglement or cable damage.
- Ensure the monitor is secure. The suction mount can be moistened to enhance the seal to the windscreen.
- Do not leave the monitor in a visible place when the vehicle is unattended.
- Use your own depth perception; objects may appear further away than they actually are.

Turning the Monitor power On/Off

To turn the monitor on:

- Press and hold the power key for 3 seconds. The Android operating system will start and present you with a menu.

To turn the monitor off:

- Press and hold the power key for 3 seconds. The power off menu will appear; select the Power off option.

Using the Monitor- Home screen Apps

The monitor uses the Android operating system which is widely used on mobile phones and tablets. Some of the basic Android functions are covered in this manual, but further information can be found in the Android quick start guide available in electronic format from this link:

<https://sargentltd.co.uk/tech-support/article/Wireless-Reversing-System/47>



If you are unable to view the documents on line, please contact the supplier, your dealer or Swift for an electronic or paper copy.



Android Settings – use this to setup the initial WiFi connection



Android Music – use this to play any installed music



Android Calculator – select this to use the built in calculator



Reversing Camera – select this to view the reversing camera



Satellite Navigation – select this to access the satellite navigation

Initial WiFi set-up



Note: this will usually have been completed by your dealer before delivery. Turn the monitor on and wait for the unit to start up.

- On the menu screen select the Android settings icon .
- Turn the Wi-Fi setting on by sliding the on-screen switch.
- Touch the Wi-Fi setting to show a list of available networks.
- The camera system uses the WIFI_AVIN network, so select this.
- Touch in the password area and enter the password 12345678 to connect.
- Touch done and then connect, WIFI AVIN should then state 'Connected'
- Touch the back button twice to return to the main menu.
- This is a one off operation. The unit will remember the settings for future use.

Note: for security reasons the caravan transmitter only connects to one receiver (monitor, phone or tablet) at a time. Please ensure you disconnect one device before trying to connect another.

The Reversing Camera App



Select this to launch the reversing camera App.

- To view the camera select the camera App on the menu screen.
- The software will connect to the transmitter and the camera image will be shown on screen.

The following describes the available buttons / options within the camera App



Use this button to record the video being displayed (see note)



Not used



Use this button to take a photo of the onscreen image



Signal indicator
white = Signal being received
grey = no signal



Use this button to view a list of recorded video files or photos



Use this button to change the default network name and password (see note)

Note: The unit has a limited storage memory, so try to avoid recording long sections of video otherwise you may fill up the available storage space. The storage space can be expanded by adding a Micro SD card to the unit, inserting it in the slot provided. The unit will work with a card from 4Gb to 32Gb. Please use a good quality card, ideally class 6 or above.

Note: It is possible to change the default network name and password. This should not be necessary and is not recommended, but can be done if you have two systems close together and would like each to be identified differently.

Press the settings button to change the network name and password. When the information is changed the connection to the transmitter will be lost and you will need to reconnect the WiFi using the initial WiFi setup process but this time using your new network name and password.

If something goes wrong with this process the transmitter can be reset back to the factory settings. To do this access the transmitter (located above the number plate under the black panel) and with the transmitter powered up, press the reset button. The network name will be reset to WIFI_AVIN and the password to 12345678.

The Satellite Navigation App



Select this to access the satellite navigation App.

The first time you start the SatNav App you will have to choose some options and default settings. Please read the guidance on screen.

- Select language, Done
- Select Yes/No
- Next
- Select voice, we recommend English UK James, next
- Set or change the Units format (Miles or Metres etc.) next.
- Set or change route settings, next
- Finish

SWITCHING BETWEEN APPS / USING THE APP ON YOUR ANDROID OR APPLE DEVICE

- Speed camera warnings, Leave on, Turn Off
 - The full SatNav user manual is available in electronic format from the following link: <https://sargentltd.co.uk/tech-support/article/Wireless-Reversing-System/47>
- If you are unable to view the documents on line, please contact the supplier, your dealer or Swift for an electronic or paper copy.
- The SatNav software is quite straight forward to use, but the following points will help with the initial operation.
 - When entering a UK post code please remember to enter the space between the two halves of the code, i.e enter HU17 OTB not HU170TB.
 - When entering a destination for the first time you may need to change the onscreen keyboard format. To explain this here is a walkthrough to enter a post code address.
 - Select Destination, Find address
 - Press on Town, then if the keyboard looks incorrect, press More, select the English keyboard (either ABC, or QWERTY format)
 - Enter a test post code (HU17 OTB), pressing the 123 button to switch to number entry and please noting the space (...)
 - Select the required address from the list
 - If known, enter the house number (39), Done
 - Press GO
 - An overview of the route is shown for a short while, the unit will start navigating

Switching between Apps



The following Android system buttons (at the bottom of the screen) can be used to switch between App's, close App's or go to the previous screen.



BACK: Opens the previous screen you were working in, even if it was in a different App. Once you back up to the Home screen, you can't go back any further.



HOME: Return to the home screen.



RECENT APPS: Opens the previous screen you were working in, even if it was in a different app. Once you back up to the Home screen, you can't go back any further

Using the separate App on your Android or Apple iOS phone

If you don't want to use the supplied monitor you can use the separate App on an Android or Apple iOS device.

Head to the appropriate App store (Android or Apple) and search for WIFI_AVIN. Download and install the App.

Initial WiFi setup - The camera system creates its own WiFi Network for the monitor or your own phone or tablet device to connect to, so you need to setup this initial connection.

- On the device menu select the settings option to connect to a new network.
- Turn Wi-Fi on if it is not on already.
- View the list of available networks.
- The camera system uses the **WIFI_AVIN** network, so select this.
- Enter the default password **12345678** to connect.
- Now return to the main menu and start the App.
- If the caravan is connected to the car and the engine is running, the camera image will be shown on the screen.

Caravan Reversing Camera Care

The camera fitted to the rear of the caravan has no serviceable parts, do not open the case. However the following precautions should be observed.

- Check that the camera lens is clean as dirt can obscure the view.
- Never use a power washer or water jet to clean the camera or transmitter.

Product Specification -

Caravan Camera Kit

Transmission Frequency	2400MHz – 2483.5MHz
Unobstructed Effective Range	100m (approx.)
Operating Temperature	0°C – 60°C
Storage Temperature	25°C
Frame Rate	30fps
Video Compression	H.264
Encryption:	WPA2
Operating Humidity:	20% – 80% RH
Monitor Display:	5" TFT LCD
Monitor battery Life:	1 hour (approx.)
Monitor Power Supply:	DC 5V via Car Adaptor

Warranty and Support

For warranty information and technical support, please contact:

Sargent Electrical Services Ltd

If your Caravan Reversing Camera Kit requires service, please discuss this with your dealer or direct with us.



Sargent Electrical Services Ltd
 Unit 39, Tokenspire Business Park
 Beverley
 East Yorkshire HU17 0TB
 Telephone: 01482 678981
 Fax: 01482 678987
 E-Mail: support@sargentltd.co.uk

Vehicle modifications	162
Lubricant hinges etc.	162
Caravan exterior	162
Acrylic windows	162
Colour reference exterior	163
Bonded roof	163
Step on hitch cover	163
Road lights	163
Caravan interior	163
Work surfaces	164
Stainless steel bowl	167
Bathroom/shower.....	167
Furniture and doors	167
Condensation.....	167
Winterisation.....	168
AL-KO Chassis	170

10.1 Vehicle modifications

As the owner of a Swift Group Product, you are able to make any modifications you wish, either by yourself or through a dealer, without affecting the Swift 3/6/10 Year Warranty.

However, please be aware that any issues, resulting directly or indirectly, from a modification or fitment of a non-standard part, will not be covered by The Swift Group Warranty.

Note: Before carrying out any DIY work within the warranty period (3/6/10 years) please check with your Swift Group dealer.

Note: Replacement parts
The Swift Group recommend that only OEM approved replacement parts are used.

10.2 Lubricant Hinges etc.

If a lubricant is required for Interior hinges, Sliding door tracks, Bottle box hinges, Exterior door hinges, Plastic tracking etc. We recommend "Ambersil 40+" this is readily available from most DIY/ Automotive spare part retailers

CAUTION: WD40 is not recommended for external or internal use. WD40 attacks paintwork and sealants.

10.3 Caravan exterior

Plastic Panels (GRP)

These are used for front and rear panels, side walls and roof.

Cleaning

1. Wash the caravan regularly with mild detergent. Rinse with cold water and dry the vehicle with a chamois or microfiber cloth.
2. For better protection a similar coloured good quality car wax may be applied.

For sealed areas a mild soap is the best way to clean without affecting the sealant.

CAUTION: Acid or alkaline based cleaners or solvents should not be used.

CAUTION: Under no circumstances use any abrasive cleaning agents or solvents on the exterior panels.

Care should be taken as the silicon in some polishes can attack the rubber used on the exterior for seals and gaskets.

CAUTION: Do not wash your caravan with a high pressure washer as these can permanently damage the seals of your caravan.

10.4 Acrylic windows

Cleaning windows

While the acrylic used for the windows is very durable, it can be scratched with relative ease and therefore, care must be taken when cleaning your vehicle.

CAUTION: Do not use aggressive cleaning products.

Wash windows carefully, as you would with the paintwork of your car, do not scrub windows prior to removing surface dirt and film with a hose pipe - trapped dirt could cause scratching.

Wash with a solution of warm soapy water, windows can then be dried off with chamois or microfiber cloth. Take care to ensure that the drying cloth is clean and free from grit.

Small scratches can be removed, consult your dealer.

Catches and stays do not require any special attention or lubrication.

Window Condensation

Unlike domestic double glazed windows, your caravan windows are not vacuum sealed instead the double panes of acrylic plastic are fitted with a breathable plug on the inner pane.

It is possible, in weather where extremes in temperatures occur between night and day, that customer will notice condensation between the panes. The same phenomenon may also occur when washing your vehicle on a hot day.

The condensation should clear itself when the ambient conditions return to normal and

the air between the panes dries. However, if this is taking a longer time than required, the breathable plug (normally located in the top corner of the window) can be removed, with a pin or sharp object, and replaced when the panes are dry. Care should be taken when doing this.

10.5 Colour reference exterior

If you require a touch-up paint or a respray of a caravan, the correct colour code for all white components is Fiat White 249.

Please be aware that colours can fade over time, and therefore, if the vehicle is more than a few years old, it is suggested a colour match be obtained.

If these are small areas that do not require a full respray of the entire panel you can use an over the counter polishing compound to return the original finish. We would always recommend that an inconspicuous area of the caravan is tested beforehand.

10.6 Bonded roof

The roof of your caravan is made from a bonded construction. Care should be taken when cleaning the roof not to walk directly on the roof. If access to the roof is required the weight of a person should be spread across a larger area using a spreader board.

⚠️ WARNING: Use suitable access equipment and extreme care should be taken when working at heights.

10.7 Step on hitch cover

Where a step on hitch cover is fitted, customers are reminded only to stand on the designated areas, identified with black anti-slip matting. Stepping elsewhere on the hitch cover may result in damage to the hitch cover.

Models without a step on hitch cover are not suitable for standing on and failure to follow these simple instructions may result in premature failure or cracking which will not be covered by any guarantees (including extended warranties).

10.8 Road Lights

All lights fitted to your caravan are LED lights with no user serviceable parts. Should a light cease to operate then the whole unit requires replacing. We recommend that this is carried out by a Swift Group service centre.

10.9 Caravan interior

Follow these guidelines to ensure your investment is receiving the very best attention.

Side Walls, Roof Lining

A simple wipe over with a damp cloth and a very mild detergent is all that is needed.

Soft Furnishings

Should be vacuumed occasionally to remove grit and sand and help to keep its smart appearance and ensure long life. The upholstery can be cleaned with a mild, reputable upholstery cleaner. It is recommended that the curtains and pelmets are specialist cleaned only. The foam used in cushions is manufactured to meet fire regulations. It requires time to return to its normal position after prolonged use.

Swift Shield Fabric

(Optional)

The Swift Shield fabric fitted to some Swift Group products is a luxury stain resistant durable fabric using Aquaclean® technology. This is a revolutionary fabric treatment that allows you to clean stains using water only. This provides you with simple fabric maintenance in the minimum amount of time.

Cleaning Instructions

Aquaclean® helps to remove the majority of household stains (wine, ink, sauce, fat, mud, chocolate, cream, etc.) in three simple steps:



1. Remove any excess residue on the upholstery



2. Apply water over the stain, either directly or using a damp cloth. Wait a few seconds.



3. Press down over the stain with a damp cloth and rub gently over the fabric in circular movements. If the stain does not come off completely, repeat the process as required.

For further details and stain cleaning demo videos visit the Cleaning Gallery on the Aquaclean® web site:

<https://www.aquaclean.com/en-es>

Aquaclean fabrics cannot accept any responsibility for misuse of the fabric by allowing bleach or dissolvent substances coming into contact with it.

Front locker and sunroof

The front locker is made from ABS thermoformed plastics, which are easy clean textured surfaces. To ensure long life and prevent damage you must not use any cleaning materials including solvents or aggressive cleaning materials. We recommend the use of warm soapy water, applied with a damp cloth.

Where a front sunroof is fitted, directly above the front windows, it is recommended that the blind be left open during use (or storage) in high temperatures or direct sunlight, to avoid a build-up of heat within this non-opening window.

10.10 Work Surfaces

Cleaning

Do not use abrasives, chemically treated cloths or aggressive detergents on work surfaces and tables as these may cause damage.

Clean worktop surfaces, furniture and door fascias with a soft, slightly damp cloth, dry off with a soft cloth.

Heat damage

Do not place hot objects on laminated surfaces and tables. Any temperatures 70°C and over may cause permanent damage.

FENIX Work surfaces

(Elegance & Basecamp)

Ordinary maintenance

FENIX NTM surface should be cleaned regularly but does not require any special maintenance, just a damp cloth with warm water or mild detergents. Almost all normal household cleaning products or disinfectants are perfectly well tolerated. It is suggested to use a melamine foam sponge - also known as magic sponge - for the normal cleaning and maintenance of the surface.

Extraordinary maintenance

In case of dirt which cannot be cleaned with normal household detergents, due to the irregular topography and closed surface of FENIX NTM, the use of non-aggressive aromatic solvents (acetone) is suggested. In case of micro scratches, please refer to the specific surface thermal healing instructions.

Recommendations for cleaning the surface of FENIX NTM

The table below shows the cleaning products and methods best suited to different types of dirt.

General precautions

For best results in cleaning FENIX NTM, it is important to remember certain precautions:

- Although very durable, the surface of FENIX NTM must still never be treated with products containing abrasive substances, abrasive sponges or unsuitable products, such as sandpaper or steel wool;
- Products with a high acid or very alkaline content should be avoided because they can stain the surface;
- When using solvents, the cloth used must be perfectly clean so as not to leave marks on the FENIX NTM surface. Any streaks can still be removed by rinsing with hot water and drying;
- Avoid furniture polishes and wax based cleaners in general, because they tend to form a sticky layer on the dense FENIX NTM surface, to which the dirt adheres.

Type of dirt	Recommended cleaning products and method
Syrup, fruit juice, jam, spirits, milk, tea, coffee, wine, soap and ink	Water with a sponge
Animal and vegetable fats, sauces, dry blood, dry wine and spirits, eggs	Cold water with soap or household detergent with a sponge
Smoke, gelatine, vegetable and vinyl based glues, organic waste, gum arabic	Hot water with soap or household detergent with a sponge
Hair spray, vegetable oil, biro and felt tip, pens, wax foundations and greasy make-up, residual solvent marks	MEK, alcohol, acetone with a cotton cloth
Nail polish, spray lacquer, linseed oil	Acetone with a cotton cloth
Synthetic oil paints	Trilene nitre based solvent with a cotton cloth
Neoprene glues	Trichloroethane with a cotton cloth
Traces of silicone	Wooden or plastic scraper, taking care not to scratch the surface
Lime deposits	Detergents containing low percentages of citric or acetic acid (10% max.)

Maintenance Instructions

Kitchen Drainer and Cutting Board

You should not stand hot items on to the removable plastic kitchen drainer. To wash use only warm soapy water, do not use chemicals and bleach.

Melamine foam Sponge

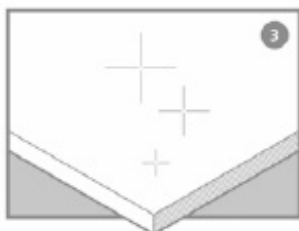
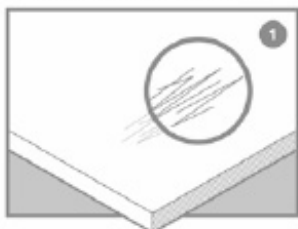

**Maintenance Instructions
Iron**

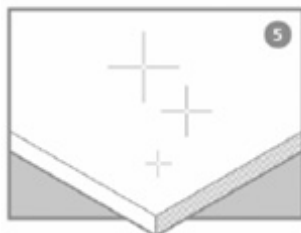
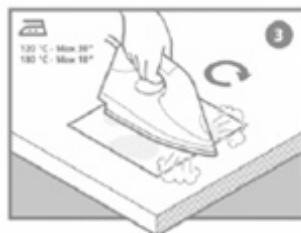
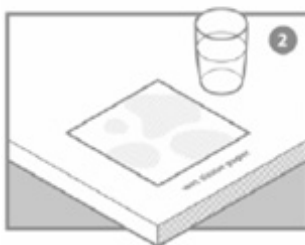
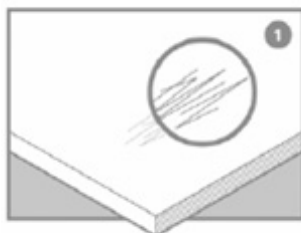

Kitchen Drainer and Cutting Board

You should not stand hot items on to the removable plastic kitchen drainer. To wash use only warm soapy water, do not use chemicals and bleach.

10.11 Stainless steel bowl

Care Instructions

After use always remove any plastic bowl or mat, rinse down the surface and dry with a soft cloth to prevent spotting. For more stubborn dirt or grease a non-abrasive multi-purpose cream cleaner, such as CIF, may be used. To preserve the appearance of your bowl we recommend plastic bowls or mats are not stored in the sink during transit.

The quality of water can affect your bowl's appearance. If the water has high iron content, a brown surface stain can form on the bowl giving the appearance of rust. Additionally, in areas with a high concentration of minerals, or with over-softened water, a white film may develop on the sink. To combat these problems, towel dry the sink after use, and clean at least once every week.

Surface scratching will be most noticeable on highly polished components. These marks are usually only superficial and can be removed with a proprietary stainless steel cleaner/polish. If the surface has a directional polished grain always clean along the grain and **NOT** across. Never use wire wool pads to clean the surface.

Cleaning agents containing bleach should **NOT** be left in contact with stainless steel. This includes many of the new "trigger-dispense" products and some multi surface cream and hand cleaners. Also leaving rubber mats or dishpans in the sink can lead to surface rust or pitting, always remove them after use.

10.12 Bathroom/shower

These products should be cleaned immediately after use. Apply a warm, mild soapy water solution with a soft cloth and rinse with clean water immediately. Abrasive materials must never be used.

Shower Bi-fold Door

(When fitted)

The door panels should be cleaned with warm soapy water and a non-abrasive cloth/sponge.

Never use an abrasive or aggressive cleaning agent as these may harm the product and cause premature failure.

Vuplex®, a proprietary plastic cleaner, can also be used. This can be obtained from outlets such as Amazon, ebay etc.

10.13 Furniture and doors

Cleaning

A simple wipe over with a damp cloth should be all that is required. Polishing with a proprietary brand of wax polish enhances and maintains furniture in showroom condition.

It must be remembered that because the frames of the doors are made from a natural product, they can be affected by temperature and humidity and may bow under certain conditions. As conditions change they should revert to their original positions.

Door Adjustment

In order to provide customers with the latest designs of door furniture it is possible, due to the use of natural wood, that warping may occur. This should not detract from the correct functioning of items fitted in the caravan.

Information

During the normal travelling vehicle vibration and flexing may cause some of the furniture doors to become out of alignment.

For your convenience many hinges are adjustable.

10.14 Condensation

What is condensation

Condensation is the process of change of water from its gaseous form (water vapour) into liquid water when it comes into contact with a surface that is cold. Condensation generally occurs when warm air cools quickly and loses its capacity to hold water vapour, and as a result water vapour condenses to form droplets.

Why condensation occurs

Condensation occurs when warm moist air meets a cold surface. The level of condensation will depend upon humidity levels, how moist the air is and how cold the surfaces are they come into contact with.

If the temperature falls below the dew point temperature, it is quite normal for condensation to occur on any material within the caravan that is cold, for example the external walls, plastic windows etc.

When condensation occurs

Condensation occurs usually in winter months, because ambient temperatures are colder (leading to cold surfaces) and windows and roof vents are opened less so the moist air cannot escape.

Where condensation occurs

Condensation will occur where warm moist air is put into the atmosphere in areas such as in bathrooms (during showering) and in kitchen areas (during cooking).

In the enclosed space of a caravan, the moist air from the kitchen or bathroom areas will inevitably transfer to the rest of the vehicle, which in turn condenses on cold surfaces leading to visible water droplets. This issue is compounded by warm moist air being generated from normal breathing.

Condensation will also form in cold areas where air movement and ventilation is restricted (e.g. cupboards, wardrobes, under beds, etc.)

ⓘ Note: It is important to provide ventilation and air flow, so that warm moist air can escape, or be externally cooled, and to use the heating reasonably by not making the caravan too warm such that people perspire, as this will only serve to generate more moist air and therefore more condensation.

However, in particularly cold periods, where the external ambient temperatures are low, condensation may still form on external walls as the insulation levels may well not be thermally able to cope with the difference between the internal and external temperatures.

How can you prevent condensation

Provide ventilation so that moist air can escape.

a. Good ventilation of the vehicle when cooking or when drying clothes, footwear or pets is essential. Observe when windows begin to show signs of misting and increase ventilation by opening slightly by 1 cm or opening a roof vent, as these will help, but keep the habitation door closed as much as possible to retain heat.

b. If drying damp clothes or towels, open a window to ventilate the area and allow the moist air to escape.

10.15 Winterisation

The Swift Group recommends the following winterisation points for customers:

Servicing

Arrange (in advance) the yearly service and habitation check, if the caravan's next service is due while the vehicle is stored.

Electrical

If vehicle is being stored while connected to 230v Mains Hook-up:

- Ensure that the leisure battery is connected and the 20A local fuse(s) is connected.
- The isolator switch on PSU should be in the 'ON' position, however the control panel should be switched 'OFF'.
- If Alde system is installed, there is a frost protection setting, which can be used.
- Vehicles can be left in this condition for extended periods, with the charger operating to maintain the battery. However, periodic maintenance and inspection is recommended, this should include the battery condition.

If vehicle is being stored not connected to 230v Mains Hook-up:

- Connect the caravan to a 230v mains hook up with charger operating for at least 24 hours prior to placing caravan in storage
- Ensure the isolation button on PSU is in the 'OFF' position (button out).
- Ensure leisure battery is connected and 20A local fuse(s) is in place, if an alarm or tracker device is fitted.

- The alarm will eventually drain the leisure battery - we recommend regular (monthly) inspection / re-charging of leisure battery via appropriate means. A solar panel can be used to provide an alternative power source to extend the time before the leisure battery requires re-charging.
- The battery should not be adversely affected by winter temperatures but the level of charge should be maintained to maximise the life span of the battery. This can be achieved using an automotive type battery charger as and when required.

Gas system

- Ensure the gas supply is isolated at the gas bottle, and ensure that the gas manifold taps are off.
- Check the age and condition of the high pressure gas hose and regulator, and replace if required.

Appliances

- Check the battery expiry date on the smoke alarm and replace or remove as required.
- Ensure the fridge is turned off.
- Clean the inside of the fridge.
- Prop the fridge door open, and if possible, the internal freezer compartment door for ventilation.
- Fit fridge vent winter covers (if available).
- Ensure all hob / oven / microwave surfaces are clean.
- If the caravan is going to be left connected to 230v supply while not in use, ensure the microwave is unplugged.

Toilet

- Drain the toilet reservoir.
- Empty the toilet cassette
- Clean and dry the whole toilet
- Lubricate the seals with a suitable lubricant.
- Loosen the cap of the pour out spout to ventilate the waste-holding tank.
- Please See the Thetford toilet owner's manual for a more detailed instructions.

Note: During storage Thetford advise leaving the blade open to prevent damage to the blade

Exterior (Body / Chassis)

- Ensure that all windows, skylights and access doors are closed and secured.
- Ensure all fixed ventilation points (high and low) are clear from debris and obstructions.
- Ensure the vehicle is not parked where falling debris (i.e. leaves, tree sap) could cause damage.
- Avoid leaving the vehicle parked in soft ground, long grass or a potential area where standing water may form.
- Lubricate relevant points on the chassis.
- Remove road wheels, using the correct jacking points and suitable axle stands, or if being left on road wheels rotate wheels (every two weeks) and ensure the correct tyre pressures are maintained.
- A purpose made cover maybe used, but please ensure the cover is a good fit, breathable and securely fitted.

Note: A poorly fitted cover can rub and damage the bodywork. Non-breathable covers will encourage mould to grow and if fitted prevent the operation of a roof mounted solar panel (model specific)

Interior (Furniture / furnishings)

- Open all lockers and internal doors, to ensure good circulation.
- Remove cushions and store them in a dry location or ensure all cushions are placed in a well ventilated area.
- Close all blinds and curtains. Customers are reminded to check the tension on blinds after storage if left closed for long periods.
- Thoroughly ventilate the caravan by opening doors or windows periodically.
- Placing water absorbent crystals in the van during the winter months, will help reduce moisture levels and mould growth.
- We do not recommend leaving portable heaters in the van unattended.

Water system

Water expands as it is frozen, and so trapped water, when it expands, can damage the tap / valve / pump or pipe it is trapped within. For this reason, (in addition to reasons of hygiene), the water system should be fully drained when not in use, particularly in colder weather.

Follow the basic steps outlined below to remove water from the system (current caravans):

- Disconnect any external water source, external submersible hose or pump.
- Locate the 'Yellow' drain valve, which is floor mounted and will be next to the water heater. Move the lever on this valve to the vertical.
- If a water tank is fitted, open the tank drain valve located on the floor, next to the heater drain valve as above.
- Open one of the taps (the kitchen tap is the most convenient) to the middle (hot and cold mix) position.
- Turn on the pump using the button on the control panel, and leave the pump running until water no longer flows from the tap.
- Open the vanity tap and shower tap mixer, again to the centre hot and cold position and leave them open whilst the caravan is out of use.
- Also remove the shower head, and leave the head in an upright position.
- If present connect the external shower handset and fully open to drain, disconnect and store.

After a short while the majority of water will have left the plumbing system. At this point however it is still important to ensure that the pump itself is 'dry'. During this part of the winterisation, a suitable absorbent cloth or container should be used to catch a small amount of spilled water that will result.

The pump should be disconnected on the output side of the pump, and run for a short while to expel any water contained within the pump body and filter. This is also a good time to disassemble and clean (if necessary) the filter fitted on the input side of the pump.

The easiest method of disconnecting the pump is to remove the quick-release tabs from the Posi-flo type pump (details of releasing push fit plumbing connections can be found in section 7.1).

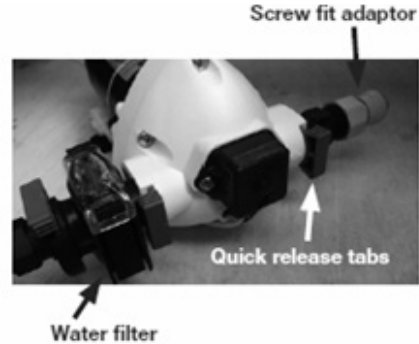

10.16 AL-KO chassis

Galvanised Chassis

Manufactured from high quality steel, the chassis has extra deep sections to provide strength at points of maximum stress. Large elongated holes are punched in the longitudinal chassis members, to reduce weight to a minimum. Each hole incorporates a return flange to maintain the required strength and provide rigidity in the extra deep sections.

The chassis frame is of a bolted construction which allows replacement of individual parts should the need arise.

The chassis is Hot Dipped Galvanised. This is regarded as one of the best forms of corrosion protection. It does however require minimal maintenance in certain circumstances and should, if properly maintained, last the lifetime of the vehicle.

When new, the chassis is of a bright and shiny appearance. As the galvanising cures during the initial 2/3 month period, this will gradually change to a medium/dark grey colour. This grey finish is the ideal, giving the correct protective coating. During this curing period the surface should be protected to avoid possible wet storage stain, in the form of a soft, light coloured, porous, oxidation layer. If the chassis members are in contact with any salt deposits from roads this should immediately be washed off with clean water. Salt attracts moisture allowing the surfaces to remain wet, this prevents curing and also allows formation of wet storage stain.

It is recommended that the chassis/ components are washed off with clean water on an annual basis (especially after winter usage), to avoid undesirable build-up of salt and dirt deposits.

After washing allow an adequate flow of dry air to ensure that the chassis dries off completely.

To keep the chassis in good condition the caravan should not be parked on long grass where the air flow around the chassis is hindered and the dampness retained.

The galvanised chassis should not be painted or subjected to any other protective treatment.

Should the galvanising become superficially damaged exposing the steel core, this should be cleaned and treated with a Cold Galvanising Spray obtainable from vehicle accessory outlets.

Damage to chassis members through impact etc, MUST NOT be straightened or welded. Damaged chassis members MUST be replaced.

Drilling or Welding of Parts or Accessories

The chassis is designed and built to precise tolerances and must not be drilled or welded (except in accordance with certain AL-KO Accessory Operating Instructions). Failure to comply will invalidate all warranties.

CAUTION: Do not weld or drill any chassis parts without the expressed permission of Al-Ko. It will invalidate your warranty

Brakes, Overrun, Suspension & Hitch head

For details of how to maintain these systems please refer the Al-Ko handbook supplied with your caravan

Corner Steadies

Corner Steadies are as stated, for the purpose of steadying the caravan corners. They are NOT JACKS AND SHOULD NEVER BE USED AS SUCH. The screw and pivot pins should be lubricated periodically to ensure their satisfactory operation.

Road Wheels

The condition of wheels and tyres should be checked regularly, particularly for distortion of flanges and the wheel dish. Wheels that are damaged or distorted, or have wheel bolt seatings cracked or deformed must not be repaired or used in service - these must be replaced. See section 5.14

WARNING: The torque settings should be re-checked regularly

Jockey Wheel

Lubricate screw thread and wheel spindle periodically.

Spare Wheel Carriers

The telescopic frame tubes should be lubricated periodically.



Owners club	174
Spares and aftersales	174
Repair facilities	174
Clubs and trade bodies	175
Change of ownership	176
Index	178

11.1 Owners club

The Owners Club is a completely independent organisation run for the benefit of the caravan owners. They have numerous rallies during the year in various parts of the country. Apart from the friendliness and companionship the Club generates it is also actively engaged in charity work for those less fortunate than ourselves. There are links to the owner's club websites from the Swift Group website www.swiftgroup.co.uk

11.2 Spares and after sales

A catalogue of spare parts are available through our Swift Group Dealer Network, from door catches through to spare wheels. Please note, all parts enquiries must be directed through your dealer, as the Swift Group does not operate a direct retail service.

We endeavour to supply parts for vehicles up to 8 years old. If the original part is no longer available your dealer should be able to source a suitable alternative.

Note: Please remember to quote chassis number when ordering any items from your dealer

11.3 Repair facilities

Should you be unfortunate to encounter damage to your vehicle, we have a number of approved workshops and dealerships with workshop facilities to undertake such repairs. Details of which can be found via our website: www.swiftgroup.co.uk/find-a-dealer

11.4 Clubs and trade bodies

The enjoyment of caravanning can be greatly enhanced by membership of one or more of the various caravanning, motoring and holiday clubs. Here are some useful addresses:

Caravan Clubs

The Caravan Club

East Grinstead House,
East Grinstead
West Sussex,
RH19 1UA
Tel: 01342 326944
www.caravanclub.co.uk

The Camping and Caravanning Club

Greenfields House,
Westwood Way,
Coventry,
West Midlands.
Tel: 024 7647 5448
www.campingandcaravanningclub.co.uk

Motoring Associations

Automobile Association (AA)

Fanum House,
Basingstoke,
Hants.
RG1 2EA
Tel: 08705 448866
www.theaa.co.uk
e-mail: customer.services@theaa.com

RAC Motoring Services

8 Surrey St.
Norwich
Norfolk
NR1 3NG
Tel: 01922 437 000
www.rac.co.uk

Green Flag National Breakdown

Tel: 0845 246 1557
www.greenflag.com

RBS Insurance

West Moreland Road
Bromley,
Kent
BR1 1DP
0800 051 3030

Trade Association

NCC

Catherine House,
Victoria Road,
Aldershot,
Hampshire,
GU11 1SS
Tel: 01252 318251
www.thencc.org.uk
e-mail: info@thencc.org.uk

CHANGE OF OWNERSHIP

11.5 Change of ownership

Notification of change of ownership

As the new second hand owner, please notify the Swift Group of the change of ownership by completing this page, detaching it and sending it to:

Customer Services Department Swift Group Limited, Dunswell Road, Cottingham, East Yorkshire, HU16 4JX.

Note: Warranties are only transferable providing the terms and conditions of the warranty have been met by the previous owner(s). Please see warranty information at the beginning of this handbook for full details. The 'Extended Body shell warranty' is a non-transferable warranty.

CHANGE OF OWNERSHIP

Details of caravan:	Model:	
	Chassis No:	
New owner:	Name:	
	Address:	
	Email:	
	Telephone:	
	Mobile:	
	Date of purchase	
Previous Owner:	Name:	
	Address:	
	Email:	
	Telephone:	
	Mobile:	
	Date of purchase	

Symbols	
13 pin connection	41
13 pin socket	43
230V mains electrical equipment	93
A	
Acrylic windows	162
AKS 3004	39
Alarm system	55
Alde compact boilers	128
AL-KO AKS 3004 stabiliser	47
AL-KO ATC trailer control system	36
AL-KO chassis	170
AL-KO secure immobiliser	56
AL-KO side lift jack	50
Appliance consumption figures	83
Arrival on site	46
Awnings	51, 153
B	
Barbeque point	136
Bathroom/shower care	167
Battery box	84
Bonded roof	163
Breakaway cable	40
C	
Caravan clubs	175
Caravan exterior	162
Caravan handling	45
Caravan interior	163
Caravan motor movers	52
Caravan terms	30
Care of laminate	162
Change of ownership	23, 176
Changing a wheel	50
Children	17
Cleaning and care	163
Clubs and trade bodies	175
CO alarm	17
Colour reference	163
Condensation	162
Control panel	94
Cycle racks	154
D	
Dometic absorption refrigerator	131
Dometic C600 oven	132
Doors (internal)	167
Doorscreen	146
E	
Electrical overseas connection	81
Electrical system	80
Electric Heki roof light	149
Entertainment equipment	140
Escape paths	16
Exterior 230v socket	87
Exterior door	47, 145
Exterior door key	145
Exterior BBQ point	136
External shower point	137
F	
FENIX work surfaces	165
Fire and smoke alarm	16
Fire extinguisher and blanket	16, 51
Front locker and sunroof	164
Furniture care	167
G	
Galvanised steel chassis	170
Gas	17, 72
Gas bottles	51, 74
Gas cylinder changing	78
Gas faults	79
Gas hoses	75
Gas regulator	76
Gas safety advice	76, 77
Gas schematic	72
Generator	87, 107
Green Flag National Breakdown	175

- H**
- Habitation relay 87
 - Hand brake 39, 47
 - Heki care instructions 148
 - Heki midi rooflight 147
 - Heki mini rooflight 147
 - Hitching-up.....18,37
- J**
- Jacking points 50
- L**
- Lift-upbunks.....145
 - Loading 18, 33
- M**
- Measurement of nose weight 35
 - Mirrors 44
 - Modifications 162
 - Motoring associations 175
 - Motorway driving 45
 - Moving off 45
- N**
- NCC 175
- O**
- Omni-vent 150
 - Overrun device.....171
 - Owners club 174
- P**
- Plumbing connections 64
 - Plumbing troubleshooting 65
 - Preparing for the road 44
 - Pressure switch adjustment 65
 - Pre-Tow check list 44
- R**
- RAC motoring services 175
 - Radio (DAB and FM) 102
 - RBS Insurance 175
 - Repair facilities 174
 - Reversing 46
 - Reversing camera 155
 - Roller blind advice 147
- S**
- Security 54
 - Security chips 54
 - Sensor cleaning 68
 - Shower heads.....137,170
 - Snaking 36
 - Solar energy system (when fitted) 86
 - Spares and after sales customer care 174
 - Speed limits 45
 - Stability 36
 - Stainless steel bowl care 167
 - Step on hitch cover 163
 - Suitable towing vehicles 31
 - Swift Command fault finding 112
 - Swift Command power control system 92
 - Swift Command Tracker by Sargent 55
 - SwiftShield fabric 163
 - SwiftTalk.....10
- T**
- Tables 151
 - Table storage 151
 - Thermal insulation heating 11
 - Thetford Caprice cooker 132
 - Thetford K1520 Cooker 132
 - Towball 37
 - Towing vehicle's rear suspension 35
 - Towing vehicle terms 32
 - Trade association 175
 - Truma combi boiler 122
 - Truma CP Plus digital timer control 123
 - TV inlet in battery box 139
 - Types of gas 74
 - Types of tyres fitted 48
 - Typical gasschematic drawing.....72
 - Tyre maintenance 48

U

Unhitching 47

USB socket 89

V

Ventilation 17

W

Water faults 69

Water (fresh) level sensor & cleaning 68

Water pump pressure switch adjustment 65

Water system (no internal water tank) 61

Water system (with internal water tank) 62

Water system sanitising 68

Whale water heater 120

Wheelbolt tightening 18, 50

Windows 147, 162

Winterisation 168

Wiring of connecting cable and
caravan mains inlet 82

CREATING SMILES FOR LIFE



SWIFT

SWIFT GROUP

Dunswell Road
Cottingham
East Yorkshire
HU16 4JX

Tel: 01482 875740

Fax: 01482 840082

Email: enquiry@swiftgroup.co.uk

FIND OUT MORE AT **SWIFTGROUP.CO.UK**



Brochure



Layouts



Dealer



Video



Social

CARPET CLEANING GUIDE

To keep your carpet clean and fresh please follow the below recommendations.

All carpets are bleach cleanable.

Vacuum clean frequently

- For cut pile – upright cleaner (with beater bar) works best to loosen and lift dirt from pile.

Clean Areas Of High Traffic

- Apply doormats at all entrances and exits.
- Attend to entrances, doorways, frequently used areas and walkthroughs.
- Cleaning these areas first can stop dirt being spread throughout the carpet

Immediately clean stains or spills

- Far easier to remove when done immediately – for detailed information on different stains see our section on cleaning techniques and stain removal below.

Get it cleaned professionally

- Nothing beats periodic professional cleaning.
- Over time dust and other substances will dull your carpet.
- Specially formulated professional cleansers, developed for carpets, will enhance the carpet performance and increase its life.

Cleaning techniques and stain removal

Below is a list of simple techniques to help you to avoid any long term marking or staining of your investment. Generally upon finding a spill you should:

- Absorb the spill by blotting using kitchen towel or toilet paper – DO NOT RUB – continue blotting until no more liquid soaks through.
- If crusty or hard stain – scrape lightly to remove (dull edge of spoon is ideal) and vacuum to remove any excess dried crumbs or loose bits
- Firmly blot the stain using a clean sponge or cloth and warm water – DO NOT OVERSOAK CARPET.
- Repeat this process, rinsing sponge if necessary – until stain is removed.
- Using kitchen roll or toilet paper, continue to blot and soak up excess moisture. Repeat until all moisture is removed.
- Leave to dry naturally and keep the area exposed. Avoid walking on the area until completely dry.

Greasy stains

- Absorb the spill by blotting using kitchen towel or toilet paper – DO NOT RUB – continue blotting until no more liquid soaks through.
- Use citrus based cleaner or a 50% bleach/ 50% water solution with a clean sponge.
- Dampen the area and clean – DO NOT OVERSOAK CARPET
- Firmly blot the stain using a clean sponge or cloth and warm water.
- Repeat this process, rinsing sponge if necessary – until stain is removed.
- Using kitchen roll or toilet paper, continue to blot and soak up excess moisture. Repeat until all moisture is removed.
- Leave to dry naturally and keep the area exposed. Avoid walking on the area until completely dry. Do not allow pets or children near the area until fully dry.

Water-based stains (including wine)

- Absorb the spill by blotting using kitchen towel or toilet paper – DO NOT RUB – continue blotting until no more liquid soaks through.
- Firmly blot the stain using a clean sponge or cloth and warm water – DO NOT OVERSOAK CARPET.
- For more stubborn stains, use citrus based cleaner or a 50% bleach/ 50% water solution with a clean sponge.
- Repeat this process, rinsing sponge if necessary – until stain is removed.
- Using kitchen roll or toilet paper, continue to blot and soak up excess moisture. Repeat until all moisture is removed.
- Leave to dry naturally and keep the area exposed. Avoid walking on the area until completely dry. Do not allow pets or children near the area until fully dry.

Dried-in stains

- Scrape lightly to remove any large pieces.
- Vacuum to remove any excess dried crumbs or loose bits.
- For more stubborn stains, use citrus based cleaner or a 50% bleach/ 50% water solution with a clean sponge. – DO NOT OVERSOAK CARPET.
- Repeat this process, rinsing sponge if necessary – until stain is removed.
- Using kitchen roll or toilet paper, continue to blot and soak up excess moisture. Repeat until all moisture is removed.
- Leave to dry naturally and keep the area exposed. Avoid walking on the area until completely dry. Do not allow pets or children near the area until fully dry.